



User Manual



Software Version 178-69-19



GLP® JDC1 User Manual – Revision 4.0

This manual covers fixture software version 178-69-19

© 2017-2019 German Light Products GmbH. All rights reserved.

The marks 'GLP' and 'German Light Products' are trademarks registered as the property of German Light Products GmbH in Germany, in the United States of America and in other countries.

The information contained in this document is subject to change without notice. German Light Products GmbH and all affiliated companies disclaim liability for any injury, damage, direct or indirect loss, consequential or economic loss or any other loss occasioned by the use of, inability to use or reliance on the information contained in this document.

Head office:

German Light Products GmbH (GLP), Industriestrasse 2, 76307 Karlsbad, Germany
Tel (Germany): +49 7248 92719 - 0

Service & Support EMEA:

GLP, Industriestrasse 2, 76307 Karlsbad, Germany
Tel. (Germany): +49 7248 9271955
Email: support@glp.de
www.glp.de

Service & Support USA:

GLP USA, 1145 Arroyo St., Ste. A, 91340 San Fernando, California
Tel (USA): +1 818 767 8899
Support (US): info@germanlightproducts.com
www.germanlightproducts.com

Table of Contents

1. Safety	5
Key to symbols.....	5
General safety information	5
Electrical safety	6
Fire safety and protection from burns.....	7
Eye safety.....	7
Strobe safety.....	8
Installation safety and protection from personal injury	8
2. Avoiding damage	10
Transportation and storage	10
3. Product overview.....	11
4. Features	12
Beam	12
Color Plates.....	12
DMX control modes	12
Pixel grouping	14
Pixel Orientation	15
Tilt	16
Barndoor tilt operation	16
Auto-Blackout.....	16
Custom settings and factory defaults.....	17
Dimming curves.....	17
Behavior when a DMX signal is lost	17
PWM frequency.....	17
Effect offsets	17
Flash control modes.....	17
Dimmer flash control mode	18
FX	18
Plate color priority	19
Display	20
Cooling modes.....	20
Fixture information.....	20
Manual control.....	20
Test sequences	20
Service menu.....	20
Clamp attachment.....	20
5. Preparation for use	21
Included items.....	21

Mounting	21
Mounting upright on a level surface.....	22
Suspension or horizontal/angled truss mounting	22
Securing with a safety cable	23
Connecting to power	23
Installing power connectors.....	24
Main fuse.....	24
Connecting to a DMX control data link	25
Starting and stopping operation	25
Transportation and Storage	25
6. Control menus and LCD display	26
7. Control menu layout	28
8. DMX channels	32
DMX Mode 1 (Compressed Pro), 14 DMX Channels	33
DMX Mode 2 (Normal), 23 DMX Channels	38
DMX Mode 3 (SPix), 68 DMX Channels	43
DMX Mode 4 (SPix Pro), 62 DMX Channels.....	49
DMX Mode 5 (1Pix Pro), 17 DMX Channels	55
DMX Mode 6 (Easy), 11 DMX Channels.....	60
9. Plate FX patterns	64
10. Beam FX patterns	69
11. Cleaning and maintenance	72
Suggested maintenance intervals	72
Cleaning	72
GLP Service and Support	72
12. Technical Specifications	73
Plate LEDs	73
Beam LEDs.....	73
Movement	73
Connectors	73
Operating conditions	73
Shipping options.....	73
Dimensions and weight	73
13. Dimensions	74

1. Safety

Key to symbols

The following symbols are used in this manual:



Warning! Safety hazard.
Risk of severe injury or death.



Warning! Hazardous voltage.
Risk of lethal or severe electric shock.



Warning! See user manual for important safety information.



Warning! Fire hazard.



Warning! Risk of eye injury.



General safety information

Read this section carefully before installing or using the product. If you have any doubts or questions about how to use the product safely, contact your GLP® supplier for assistance. Your GLP supplier will be happy to help. If necessary, contact an authorized GLP distributor (see list of distributors at www.glp.de).

The JDC1 and this user manual are intended for use by experienced professionals with the knowledge and skills to set up, operate, and maintain high-powered, remotely controlled lighting equipment safely and efficiently. These operations require expertise that may not be provided in this manual.

- Respect all warnings and directions given in this user manual and on the product. Read this manual and familiarize yourself with the safety precautions it contains before installing or using the product. The manufacturer will take no responsibility for damages or harm resulting from disregard for the information in this manual.
 - Check the GLP website at www.glp.de and make sure that you have the latest version of this user manual. Check also that the software version indicated on page 2 of the user manual matches the version installed in the product. You can download the correct version of this user manual if necessary.
 - Make the user manual available to all installers and operators and save the manual for future reference.
 - Use the product only as directed in this user manual. Observe all markings in this user manual and on the product.
-

- Refer any service operation not described in this manual and refer all repairs to a technician authorized by GLP.
- The light source in this product may not be changed by the end user.
- Read and follow the user documentation for all additional equipment.



Electrical safety

- Do not allow the product to come into contact with water or moisture.
- Use only a source of AC mains power that complies with local building and electrical codes and has both overload and ground fault (earth fault) protection.
- Ensure that the product is electrically connected to ground (earth).
- Disconnect the product from AC mains power before carrying out any installation or maintenance work and when the product is not in use.
- Disconnect the product from power immediately if the power plug or any seal, cover, cable, or other component is damaged, defective, deformed, wet or showing signs of overheating. Do not reapply power until the product has been repaired and made safe by a technician authorized by GLP.
- Before using the product, check that all power distribution equipment and cables are in perfect condition and rated for the electrical requirements of all connected devices.
- Use only Neutrik PowerCON TRUE1 cable connectors for AC mains power input at the product's power connector.
- Use minimum 14 AWG or 1.5 mm² power input and relay cables that are minimum 16 A rated and temperature-rated to suit the application. In the USA and Canada the cables must be UL-listed, type SJT or equivalent. In the EU the cables must be type H05VV-F or equivalent.
- The supplied power input cable is rated as follows:
 - US power cable: 16 A, 14 AWG, UL listed, E304117, SJT, 4.9 ft.
 - EU power cable: 16 A, 1.5 mm², H05VV-F, 1.5 m
- If a fuse blows, replace it with one of the original type and rating only. If new fuses blow, disconnect the product from power and send it to a technician authorized by GLP for repair.



Fire safety and protection from burns

- Do not operate the product if the ambient temperature (T_a) exceeds 45°C (115°F).
- The surface of the product's casing can reach up to 160°C (320°F) during operation. Avoid contact by persons and materials. Do not install the product in a location where there is a risk of accidental contact. Allow the product to cool for at least 20 minutes before handling
- Keep the product well away from flammable materials.
- Keep all combustible materials (e.g. fabric, wood, paper) at least 1 m (3.3 ft.) away from the head.
- Ensure that there is free and unobstructed airflow around the product. Provide a minimum clearance of 100 mm (4 in.) around fans and air vents.
- Do not illuminate surfaces within 1 m (3.3 ft.) of the product. The light output from the product is powerful enough to cause burns or fire in illuminated objects at close range.
- Do not install a fuse that has a higher rating than the one originally installed in the product. Do not bypass fuses.
- Do not stick filters, masks or other materials onto the front glass. Do not block the light output in any way. The front glass becomes extremely hot during operation and can melt or ignite objects that are in contact with the surface. Ensure that the front glass is clean and unobstructed at all times in order to prevent a fire hazard and damage to the product.
- The product's optical components can focus the sun's rays, creating a risk of fire and damage. Do not expose the front of the product to sunlight or any other intense light source, even from an angle.



Eye safety

- The JDC1 is classified as a Risk Group 3 lighting fixture according to EN 62471. Possibly hazardous radiation emitted. Do not stare into the light output from the product. May be harmful to the eyes.
- Do not look at the product's light output with optical instruments or any device that may concentrate the light output.
- Make sure that persons near to or working on the product are not looking directly into the light output when the product lights up suddenly. This can happen when power is applied, when the product receives a DMX signal, or when certain control menu items are selected.

- The warning below is printed on the product. If the warning becomes impossible to read, replace it with a label reproduced from this illustration:

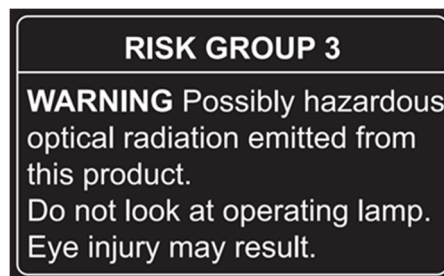

- Provide well-lit conditions to reduce the pupil diameter of anyone working on or near the product.



Strobe safety

- Flashing light, particularly at 5 - 30 Hz, may cause seizures in persons with photosensitive epilepsy. Do not use strobe effects for extended periods.
- Comply with local regulations on the use of strobe lighting and notify the public in advance with highly visible warning signs when strobe effects are used.
- If a seizure occurs, stop using strobe effects. Seek professional medical help. Note the time that the seizure starts and finishes. Call emergency medical help urgently if the seizure lasts more than five minutes, if it is the person's first seizure, or if the person is injured. While waiting for help to arrive, consider the following general advice for caring for a person who is having a seizure: Protect the affected person from injuring themselves on hard or sharp objects. If necessary, move the person to a safe place. Lay them on their side with their head supported to prevent it from hitting the floor. Loosen any tight clothing around their neck. Do not use force to hold the person or restrict their movements. Do not put anything in their mouth, including your fingers.



Installation safety and protection from personal injury

- Installation must be performed by qualified personnel only and carried out in accordance with applicable regulations such as DIN VDE 0711-217.
- The product is not portable when installed.
- Ensure that the supporting structure and installation hardware used can hold at least 10 times the weight of the load that they support.

- Suspend the product with hardware specifically designed and rated for the purpose. Check that the hardware is in perfect condition. Fasteners must be steel grade 8.8 strength or better. Rigging clamps must be half-coupler type that completely encircle the rigging truss chord.
- Screws or bolts used for mounting hardware must protrude minimum 9 mm / 0.36 in. and maximum 11 mm / 0.43 ins. into the threaded holes in the base of the fixture.
- If the product is installed in a location where it may cause injury or damage if it falls, install as directed in this manual a safety cable or similar secondary attachment that will hold the product if a primary attachment fails. The secondary attachment must be approved by an official body such as TÜV as a safety attachment for the weight that it secures, it must comply with EN 60598-2-17 Section 17.6.6, and it must be able to support a static suspended load that is ten times the weight that it secures.
- Fasten the product to a structure or surface as directed in this user manual. Do not use safety cables as the primary means of support.
- Before applying power to the product, ensure that the head can move through its full range without risk of collision.
- Check that all covers and items of rigging hardware are secure before using the product.
- Do not operate the product with missing or damaged covers, shields or any optical component.
- Restrict access below the work area and work from a stable platform whenever installing, servicing or moving the product.
- If the product becomes damaged, stop using it immediately and disconnect it from power. Do not attempt to use a product that is obviously damaged.
- Do not modify the product in any way not described in this user manual.
- Install genuine GLP parts only.

2. Avoiding damage

Do not point the front of the fixture towards the sun or other strong light sources. Strong light can cause internal damage to the fixture, melting components or starting an internal fire within seconds.

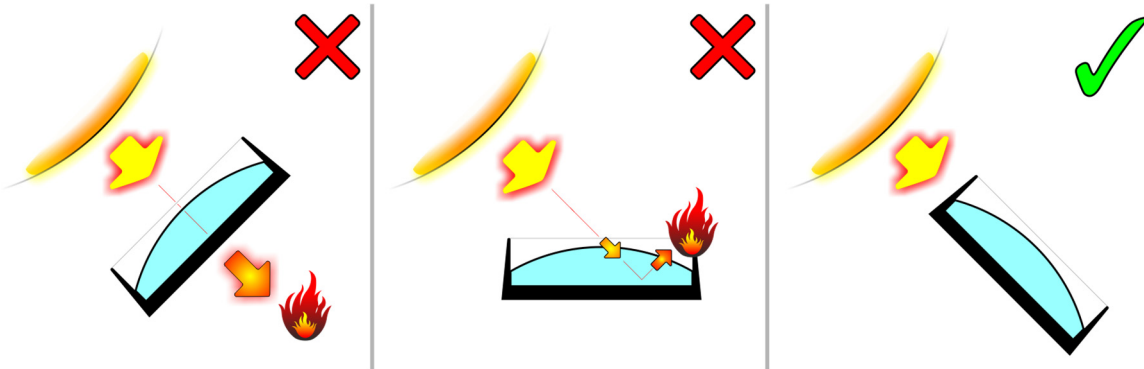

Figure 1. Avoiding damage from light sources

Damage can occur whether the fixture is powered on or off. See Figure 1. Damage can also occur if the light hits the front of the fixture at an angle: the fixture does not need to be pointing *directly* at the sun or other light source.

To avoid problems from strong light sources:

- Do not expose the front of the fixture to sunlight or any other strong light source.
- For outdoor applications during daylight, make sure that the front face of the fixture is shielded or points away from the sun, even when not in use.
- Avoid pointing other high-powered beam lights directly at the fixture.

Do not pick up or carry the fixture by the head. The LCD display is also fragile. Picking up or supporting the fixture in these spots could result in damage that is not covered by the warranty.

Use only original spare parts. Do not make any structural modifications to the fixture or you will void the product warranty.

Clean optical components only as directed. Oils, solvents, and other chemicals commonly used for cleaning can damage the lens coatings and surfaces.

Do not drop the fixture or expose it to mechanical stress.

Do not expose the fixture to heat (from other lighting fixtures for example).

Use a low-powered vacuum cleaner and soft brush only to clean cooling vents. A strong air jet can spin cooling fans so fast that they become damaged.

Transportation and storage

Transport the fixture either in a flightcase or in its original packaging to protect it from damage caused by shocks during transportation.

Store the fixture in a dry location when not in use.

3. Product overview

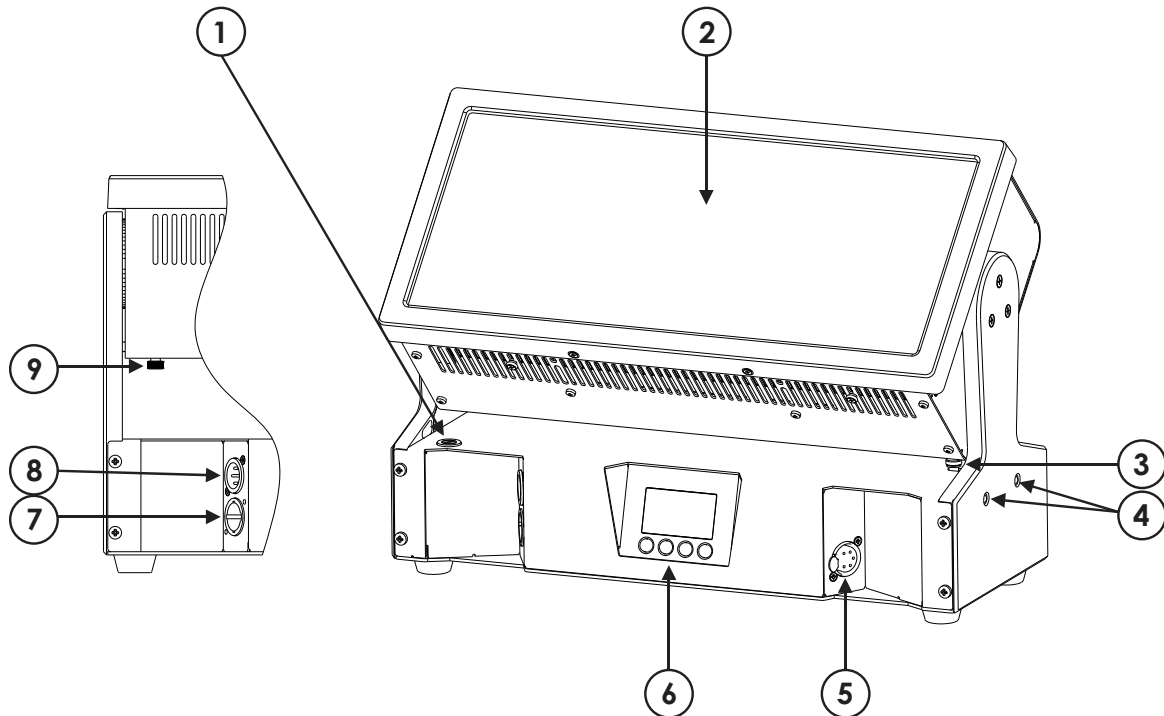

Figure 2. Product overview

- 1 – Fuseholder
- 2 – Head
- 3 – Alignment pin lever
- 4 – Alignment pins
- 5 – DMX thru (out)
- 6 – Control panel
- 7 – AC mains power in (Neutrik powerCON TRUE1)
- 8 – DMX in
- 9 –Tilt lock lever

4. Features

The impression JDC1 from GLP represents a whole new class of moving head combined strobe/color effect lighting fixture. It delivers unprecedented levels of bright, cool white light output combined with a full-face color wash panel that uses 1320 high-quality RGB LEDs. The strobe tube and the color panel can each be split into 12 segments with individual control, and the whole array can be fully pixel mapped through any standard controller. Strobe and color effects can be controlled separately, but they can also be combined for stunning strobe, blinder and wash effects. The JDC1 also features a fast-action moving head with 16-bit control and a 185° tilt range.

The JDC1 is designed for permanent or temporary indoor use. It can be used outdoors if it is protected from moisture and precautions are taken to prevent damage from direct sunlight. It may be placed upright on a level surface or suspended from a suitable structure as described in this manual.

The JDC1 is not suitable for household use, for use in any location where unattended children have access to it, or for use in permanent outdoor installations.

Beam

The JDC1 features a traditional central single-tube element, the Beam, containing 216 cool white LEDs that produce powerful white light.

You can run powerful shutter effects (including a strobe at up to 16.67 Hz) and dynamic FX patterns on the Beam, or you can operate it continuously to give high-output blinder and wash effects with an 86° beam angle. If you set an intensity on the Beam, it will be used as the background intensity if you run a shutter effect or FX pattern on the Beam.

You can control the Beam as one unit or divide it into 12 segments that you can use as separately controllable pixels.

Color Plates

The JDC1 has two RGB color panels – the Plates – on either side of the central Beam tube. Each Plate contains 660 RGB LEDs.

You can run a wide range of color effects including shutter / strobe effects and dynamic FX patterns on the Plates, or you can operate them continuously using RGB color mixing to provide a wide (148°) color wash. If you set a color mix on the Plates, it will be used as the background color if you run a shutter effect or FX pattern on the Plates.

You can control the Plates as one unit or divide them into 12 segments that you can use as separately controllable pixels.

DMX control modes

Six DMX control modes are available in the JDC1. All modes offer the same functions on DMX channels 1-7. DMX Mode 1 offers standard functions on channels 1-14, DMX Modes 2-5 offer additional functions using additional DMX channels, while DMX Mode 6 (introduced in software version 1.78) has no Plate shutter effects but offers grouped RBGW control of the Plates. Mode 6 uses only 11 channels.

The following DMX modes are available:

- **DMX Mode 1 (Compressed Pro)** uses 14 DMX channels. It gives the following control options that are used as standard in all DMX modes:
 - 16-bit control of tilt, allowing the head to be tilted through 185°, using channels 1 and 2.
 - Beam shutter effects (strobe, ramp up/down etc.) with variable intensity, duration and rate using channels 3-6.
 - Adjustment of a range of fixture settings from the DMX controller using the *Special / Control* commands on channel 7.
 - Plate shutter effects (strobe, ramp up/down etc.) with variable intensity, duration and rate using channels 8-11.
 - RGB color mixing on the Plates using channels 12-14.

- **DMX Mode 2 (Normal)** uses 23 DMX channels. It gives the following control options:
 - Standard control options on DMX channels 1-14.
 - Pre-programmed dynamic FX patterns on the Beam and the Plates, with adjustment of FX speed and of crossfades between the FX and the background using channels 15-19.
 - Master intensity and RGB color mixing on the Plates using channels 20-23.

- **DMX Mode 3 (SPix)** uses 68 DMX channels. It gives the following control options:
 - Standard control options on DMX channels 1-14.
 - Pre-programmed FX patterns using channels 15-19.
 - Master intensity and pixel-level RGB color mixing of Plate pixels 1-12 using channels 20-56.
 - Pixel-level white intensity control of Beam pixels 1-12 using channels 57-68.

For pixel layout in the JDC1, see Figure 4 on page 14.

- **DMX Mode 4 (SPix Pro)** uses 62 DMX channels. It gives the following control options:
 - Standard control options on DMX channels 1-14.
 - Pixel-level RGB color mixing of Plate pixels 1-12 using channels 15-50.
 - Pixel-level white intensity of Beam pixels 1-12 using channels 51-62.

- **DMX Mode 5 (1Pix Pro)** uses 17 DMX channels. It gives the following control options:
 - Standard control options on DMX channels 1-14.
 - Grouped RGB color mixing of the Plates using channels 15-17.

- **DMX Mode 6 (Easy)** uses 11 DMX channels. It gives the following control options:
 - Standard control options without Plate shutter effects on DMX channels 1-7.
 - Grouped RGBW color mixing of the Plates using channels 8-11.

Pixel grouping

The JDC1 gives two LED pixel grouping options, depending on which DMX mode the fixture is in:

- Control of the Beam as one unit and control of both the Plates as one unit (see Figure 3).
- Control of the Beam as 12 separate pixels and control of the Plates as 12 separate pixels (see Figure 4).

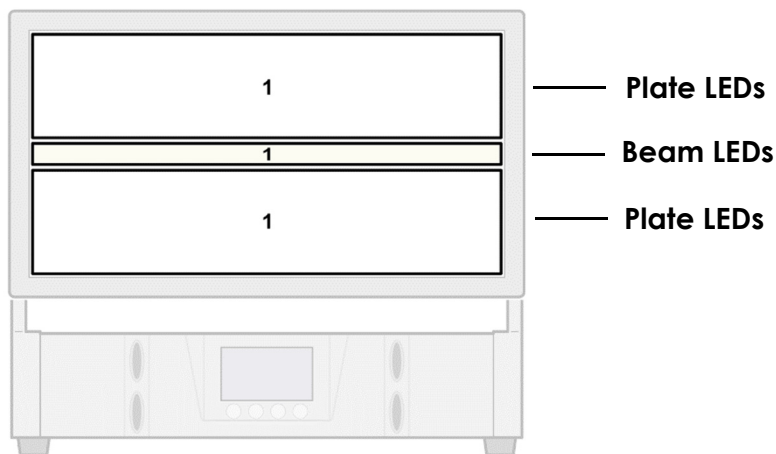
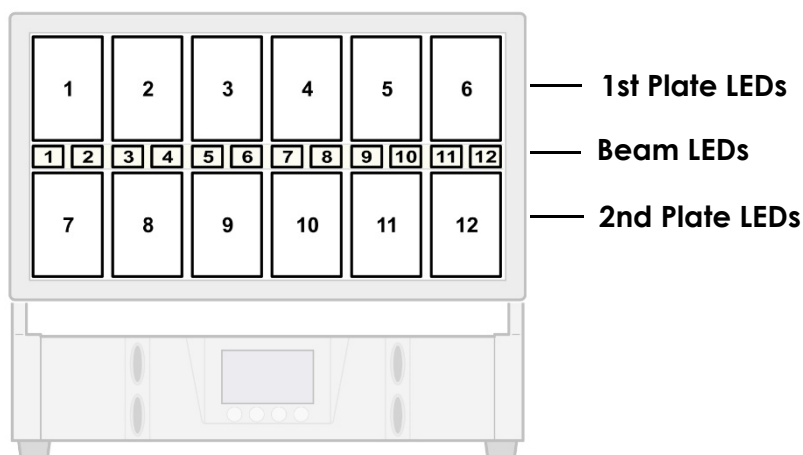

Figure 3: LEDs grouped into Beam and Plate



Pixels are numbered as seen when looking at the front of the fixture with Tilt set to 000.

Figure 4. LEDs grouped into pixels

Pixel Orientation

Figure 4 on the previous page shows the default pixel layout on the Plates. The default pixel orientation setting is:

- Pixel Orientation = **OFF** (Normal)
- 2nd Plate pixel Orientation = **OFF** (Normal).

You can invert pixel orientation by either sending a DMX command on the **Special /Control** DMX channel 7 or using the **Settings** menu in the control panel. Inverting pixels lets you set up symmetrical effects in multiple fixtures quickly without the need to reprogram cues.

See Figure 5. You can invert the order of all the pixels on the Plates and the pixels in the Beam by setting pixel orientation to **ON** (Inverted). Inversion status in the control panel display will change from **NNN** (tilt, pixel orientation and 2nd Plate pixel orientation all Normal) to **NIN** (tilt Normal, pixel orientation Inverted, 2nd Plate pixel orientation Normal) and the pixel layout will be as shown below:

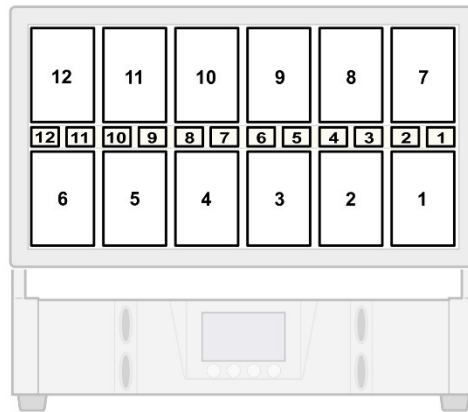

Figure 5. Pixel orientation = ON (Inverted), 2nd Plate pixel orientation = OFF (Normal)

See Figure 6. You can invert the order of the pixels on only the second Plate by setting only 2nd Plate pixel orientation to **ON** (Inverted). Inversion status in the control panel display will be **NNI** and the pixel layout will be as shown below:

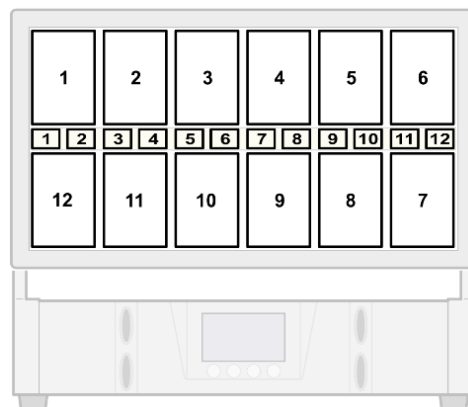

Figure 6. Pixel orientation = OFF (Normal), 2nd Plate pixel orientation = ON (Inverted)

See Figure 7. You can invert the order of all the pixels on the Plate and at the same time invert the order of the pixels on the second Plate by setting Pixel orientation to **ON** (Inverted) and 2nd pixel orientation to **ON** (Inverted). Inversion status in the control panel display will be displayed as **NII** and the pixel layout will be as shown below:

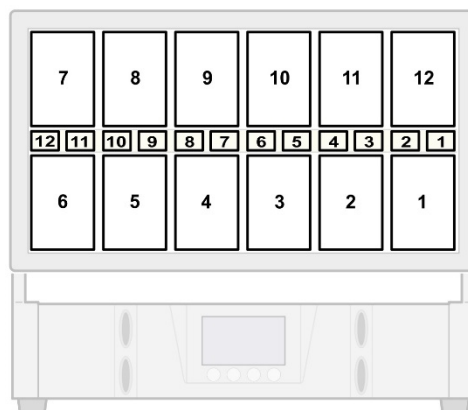

Figure 7. Pixel orientation = ON (Inverted), 2nd Plate pixel orientation = ON (Inverted)

Tilt

The head tilts through 185° with coarse and fine control channels and self-correcting position feedback.

Using the control panel, you can disable tilt position feedback and you can invert tilt direction. Inverting tilt is a fast way of creating symmetrical effects in multiple fixtures. You can also set tilt operation to one of three options:

- Enabled with DMX control.
- Disabled.
- Enabled but without DMX control. In this setting, power is applied to the tilt motor but the fixture will not respond to movement commands sent via DMX. The tilt motor will therefore act as a brake and hold the head in position.

Barndoor tilt operation

If you mount barndoors or any other accessory on the front of the fixture, set **Barndoors** to **ON** either on the Special / Control channel using DMX or in the **Tilt** menu using the control panel. Barndoor tilt operation reduces tilt speed to avoid any damage that could be caused to barndoors, if fitted, by sudden tilt movements.

Auto-Blackout

To avoid any possibility of unexpected behavior from a powerful strobe in the middle of a show or event, you can use the **Shutter** menu in the control panel to set the fixture to black out automatically if it detects an internal error. If this happens, the error will be listed in **Information – System Errors** in the control panel.

You can also set the fixture to black out automatically if more than three seconds passes without the fixture receiving a valid DMX signal.

Custom settings and factory defaults

The **Init Positions** menu in the control panel lets you replace the fixture's factory default settings with any custom settings (DMX Mode, pixel orientation, etc.) that you have stored using the control panel or via DMX. If you apply an **Init Positions – Save** command, the fixture will return to these custom settings after a power off/on cycle or after a reset.

You can delete all saved custom settings at once and return to the factory default settings using an **Init Positions – Reset** command.

Dimming curves

See illustration on right. Three dimming curves are available: **Linear**, **Soft**, and **Extra soft**. You can select a curve using the control panel or using the Special / Control DMX channel.

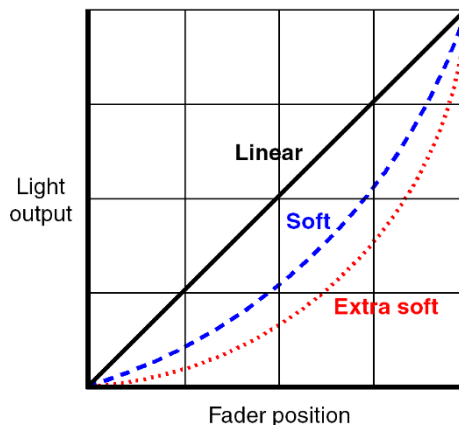

Behavior when a DMX signal is lost

You can choose how the fixture behaves if it is receiving a DMX signal but the signal stops. Three options are available in the **DMX Hold** menu in the control panel: the fixture can:

- black out immediately,
- fade down to a blackout, or
- continue obeying the last DMX command it received.

PWM frequency

You can adjust the PWM frequency of the LEDs from 582 to 618 Hz in 1 Hz increments, or you can set the PWM frequency to 1200 or 2400 Hz.

Effect offsets

Effect offsets are a fast way to set up effect chases in multiple fixtures. You can set effect offsets with starting points in the effect cycle from 10° to 360° in 10° increments.

You can set an offset for the Beam on channel 7 and set an offset for the Plates on channel 11 in all DMX modes.

Any offset that you set will apply to the standard shutter effects available in all DMX modes and also the FX patterns available in DMX Modes 2 and 3.

Flash control modes

The JDC1 offers three flash control modes that can be selected either in the control menus or via DMX on the Special / Control channel:

In **Normal** flash control mode, you set the rate and duration of Beam and Plate flashes on their respective rate and duration channels. If you increase the flash rate, the duration of flashes will not change but the intervals between flashes will become shorter. **Normal** flash control mode gives you full control over flash duration, but it means that you may need to adjust flash duration if you change the flash rate.

In **Percentage** flash control mode, you set the duration of Beam and Plate flashes on their respective duration channels as a percentage of the flash on/off cycle. Once you have set this percentage, flash duration is automatically adjusted to match flash rate. If you increase the flash rate, the duration of flashes will be reduced. **Percentage** flash control mode makes it easy to control flashes using the rate channel only.

In **Aggressive** flash control mode, flash rate and duration are controlled as in Normal flash mode, but if intensity on the Plates is below 100%, the extra available power is pushed to the Beam LEDs. This gives an even more powerful Beam flash than in the other flash modes.

If Plate LEDs are at zero intensity, enabling Aggressive flash mode will give maximum Beam flash intensity. If you increase Plate intensity, Beam and Plate output will be balanced to give the best performance. If you set Plate intensity to maximum, Beam intensity will be the same as in Normal flash mode.

Flash Modes can be changed very quickly (hold for 0.5 seconds) by programming the setting in the cue directly. This means that it is possible to swap between flash modes in the middle of a show.

Dimmer flash control mode

Producing single flashes is quick and easy if you activate **Dimmer Flash** mode in the **Settings** control menu. Activating this mode affects both the Beam and the Plates.

With Dimmer flash mode enabled, if the Shutter channel (6 for the Beam and 10 for the Plates) is set to zero, any new DMX value that you input on the Intensity channel (3 for the Beam and 8 for the Plates) will produce a single flash on the Beam or Plates. In effect, all you need to do is 'nudge the dimmer fader' to produce a flash.

FX

DMX Modes 2 and 3 include pre-programmed FX on channels 15-19. The FX are dynamic patterns that are superimposed onto the Beam and/or the Plate LEDs. Normally, all the Beam or all the Plate pixels flash at the same time. But when you select an FX, only the pattern pixels flash.

The following control options are available via DMX when using FX:

- Select FX pattern and speed for the Beam
- Select FX pattern and speed for the Plates
- Adjust crossfade time (fade time between FX pattern and background).

For tables showing all the patterns available on the Beam and the Plates, see pages 64 and 69.

Plate color priority

The JDC1 lets you set an RGB color for strobe flashes and FX patterns that are superimposed on the Plates as well as setting an RGB color for the background on the Plates. You can choose from three options that define how strobe flash and FX pattern colors are superimposed over background colors using the settings available via DMX on channel 7:

- **FX Pattern Priority:** A strobe flash or FX pattern on the Plates will always use the FX/flash color and override the plate background color.

For example, if you have created a 100% intensity red FX or flash and a 50% intensity green background, the FX or flash will always be visible as 100% intensity red over a 50% intensity green background.

- **Color Mix:** A strobe flash or FX pattern on the Plates will mix with the plate background color using additive color mixing. The color of the FX pattern or flash will change if you adjust the FX pattern / flash color, and it will also change if you adjust the plate background color.

For example, if you have created a 100% intensity red FX or flash and a 50% intensity green background, the FX or flash will appear as 100% intensity yellow over a 50% intensity green background.

- **Background Color:** An FX pattern or flash on the Plates will only be visible if no background color is set on the Plates. If a background color is set on the Plates, the FX pattern or flash will use the plate background color.

For example, if the fixture is in **Background Color** mode and you have:

- created a 100% intensity red FX or flash, and
- created a 50% intensity green background,

then the FX or flash will be not visible: you will only see the 50% intensity green background. However, if you dim the background intensity down to zero, you will see the 100% intensity red FX pattern or flash.

The Plate Color Priority settings can help you set up interesting effects when the Plates are controlled as one pixel, but they can give even richer, more complex effects when the Plates are controlled as twelve separate pixels. In **Color Mix** and **Background Color** modes, setting different Plate pixels to different colors and intensities will affect the appearance of any FX patterns or flashes that are superimposed on those pixels.

For example, if the fixture is in **Background Color** mode and you have:

- created a 100% intensity red FX or flash,
- set even-numbered pixels (2, 4, 6, etc.) to zero intensity, and
- created a 50% intensity green background on odd-numbered pixels,

then the FX or flash will only be visible on the even-numbered pixels. On the odd-numbered pixels you will only see the 50% intensity green background.

Display

The illuminated graphic LCD display with self-charging battery lets you change fixture settings even when the power is off. See Chapter 6 for settings, readouts, and related information.

You can adjust the contrast and brightness of the display in the **Display** menu in the control panel. You can also invert the display for easier reading if the fixture is flown head-down in a rig, and you can set the display to flash if the DMX signal to the fixture is lost, giving a discreet indication of DMX signal status.

Cooling modes

Cooling fans can be set to one of two modes:

- **Auto** for temperature-regulated operation. This mode optimizes cooling for quietness.
- **High** for constant high-speed operation. This mode minimizes the possibility that the fixture will reduce its light output if it exceeds thermal safety limits. This will normally only happen when the fixture is worked hard for extended periods in high ambient temperatures.

Fixture information

The **Information** menu in the control panel gives access to a long list of information items. You can see a list of any internal errors that the fixture may have detected, check main and distributed software and hardware versions, check temperature sensor readouts, see logs of operating hours and boot count and check whether the fixture is running on AC mains or battery power.

You can monitor the DMX values being received on the main DMX channels, and you can monitor cooling fan operation.

Manual control

The **Manual Control** menu in the control panel lets you reset the entire fixture, reset tilt only, or reset left or right LED drivers only. It also lets you control the main functions of the fixture without DMX.

Test sequences

The **Test** menu lets you run test sequences to ensure correct operation of Tilt movement only, color output from the RGB LEDs on the Plates only, or the entire fixture.

Service menu

The **Service** menu is password-protected and is intended for use by GLP Service.

Clamp attachment

The base provides Camlock attachment points for easy fastening of an omega clamp attachment bracket that accepts two half-coupler clamps.

5. Preparation for use



Warning! Read 'Safety' starting on page 5 for important safety information that you must understand before you install or operate the fixture.

Included items

The JDC1 is supplied with a power cord with Neutrik powerCON TRUE1 connector and an omega bracket (Part No. 87036) that lets you fasten two half-coupler rigging clamps to the fixture.

Mounting

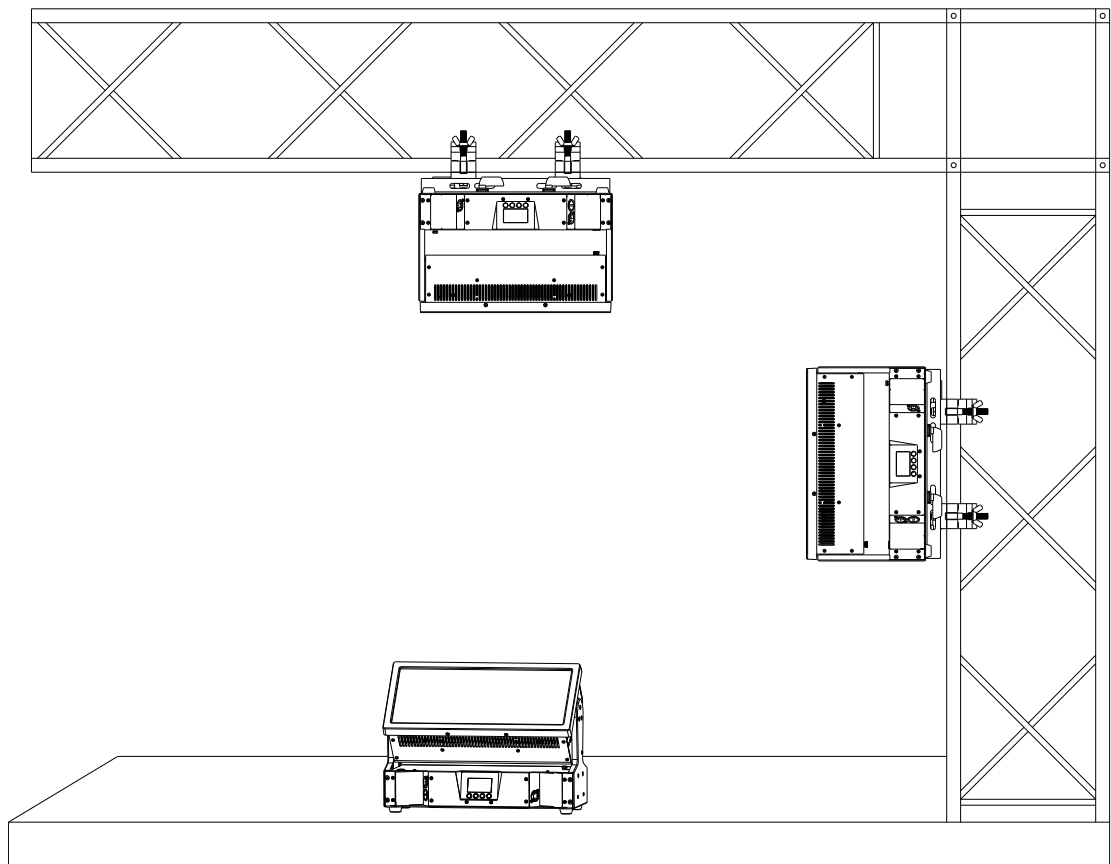

Figure 8: Mounting options (safety cable not shown)

The JDC1 may be rigged in any orientation or placed on a level surface. When installing, keep the head at least 1 m (3.3 ft.) from flammable materials including curtains and stage scenery.

Mounting upright on a level surface

The JDC1 may be placed upright on a level surface. Make sure that persons cannot accidentally touch the fixture when it is installed.

See illustration on right. You can align fixtures side by side by inserting the alignment pins (arrowed) on the right-hand side of one fixture into the holes on the left-hand side of the next fixture.

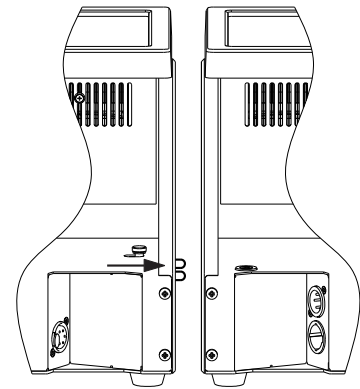

Figure 9: Alignment pins

Suspension or horizontal/angled truss mounting

You can fasten the JDC1 to a rigging truss with the head hanging vertically downwards, or you can fasten the JDC1 to a truss horizontally or at any angle. To fasten to a truss:

1. Bolt two suitable half-coupler rigging clamps to the supplied omega clamp attachment bracket.

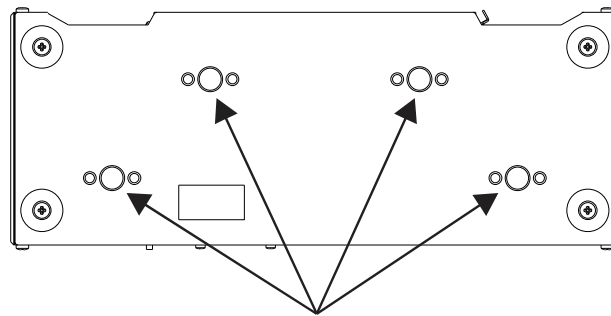

Figure 10: Camlock sockets

2. See illustration above. Fasten the omega bracket to the base of the fixture with four Camlock quarter-turn fasteners by lining up the pins in the fasteners with the keyways in the sockets, inserting the pins into the sockets and turning a full 90° clockwise to lock them.
3. Fasten the rigging clamps securely around a chord on a rigging truss or similar bar. Secure as directed below.

Securing with a safety cable

If the fixture can cause injury or damage if it falls, secure it with a secondary attachment such as a safety cable that is approved for the weight of the fixture as soon as you have fastened it in position.

To secure the fixture:

1. See illustration below. Attach a safety cable to the safety cable attachment point in the fixture base and loop it around the truss chord or bar so that it will hold the fixture if one or both of the rigging clamps fail. Take up as much slack as possible in the safety cable (by looping it more than once around a truss chord, for example).

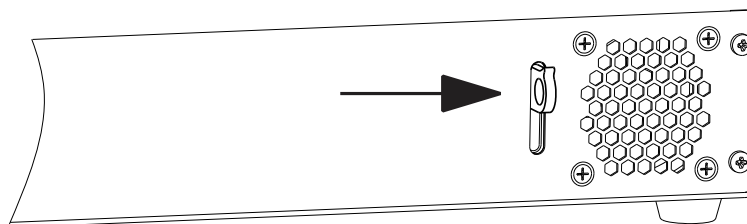

Figure 5: Safety cable attachment point

2. Make sure that the fixture is secure and that the head will not collide with any objects when it tilts.

Connecting to power

The AC mains power supply must include a connection to ground / protective earth. It must be protected against ground / earth leakage and overload. The autosensing power supply accepts AC power at 100-240 V, 50/60 Hz. Do not connect the fixture to power at any other voltage or to an external dimmer.

The JDC1 does not have a power ON/OFF switch. Power is applied to the fixture as soon as the power cable becomes live.

The JDC1 has a 3-conductor Neutrik powerCON TRUE1 socket that accepts AC power from a TRUE1 female cable connector. Although TRUE1 connectors support hot-plugging, it is still good practice to shut down power to power cables or move Power ON/OFF switches to OFF before connecting power cables to fixtures.

To connect the fixture to power:

1. If possible, shut down power to the power input cable.
2. See Figure 2 on page 11. The Neutrik powerCON TRUE1 AC mains power input socket is located on the base of the fixture. Note the position of the keys and keyways on the TRUE1 connectors. Line them up carefully, then connect the power input cable to the power input socket by inserting the cable connector and twisting clockwise to lock.

3. Check that the head is unlocked and can move freely and check that nobody is looking directly into the front of the fixture. Apply power to the fixture by energizing the power cable.

To disconnect the power cable, pull the latch on the cable connector outwards to release it, then twist the connector counterclockwise and remove it from the socket.

Installing power connectors

It is possible to install a cord cap / mains power plug that is suitable for your local convenience receptacles / mains power sockets on the supplied power input cable. If you do this, check that the cord cap / plug is rated minimum 250 V, 16 A, that it has a connection to ground / earth and that it has an integral cable grip. Follow the cord cap / plug manufacturer's assembly instructions.

If you need to install a Neutrik powerCON TRUE1 connector on a power cable, follow the instructions given in the Support area of the Neutrik website at www.neutrik.com.

Respect the color coding used in the supplied power cable and in your local mains power wiring system. US and EU systems use the color coding shown below:

	Live or L	Neutral or N	Ground / Earth or ⊕
US system	Black	White	Green
EU system	Brown	Blue	Yellow/green

Main fuse

See Figure 2 on page 11. The main fuse sits in a holder in the base.

If the fixture appears to be completely shut down even though power is applied, the main fuse may have blown. Disconnect the fixture from power before replacing the fuse. Replace only with a fuse of the same type and rating.

Connecting to a DMX control data link

The JDC1 provides 5-pin XLR IN and THRU sockets for connection to a USITT DMX512 data link.

Connectors use standard DMX pinout:

- Pin 1 = Ground
- Pin 2 = Negative / data cold
- Pin 3 = Positive / data hot.
- Pins 4 and 5 are not used.

If you would like any advice with planning and installing a DMX link, your GLP supplier will be happy to provide assistance.

Starting and stopping operation



Warning! Before you apply power to the fixture or operate it after a blackout, make sure that nobody is looking directly into the front glass from close to the fixture.

Check that the tilt lock has been released before operating the fixture.

The JDC1's TRUE1 AC mains power input connector supports hot-plugging, and it can be quickest to disconnect a live power cable if you need to shut down power urgently, but it may still be wise to show caution and connect and disconnect power cables without power applied. Apply power to the AC mains circuit to start operation. Shut down power to the AC mains circuit to stop operation.

Transportation and Storage

We strongly recommend that you transport the JDC1 either in a flightcase or in its original packaging to protect it from damage caused by shocks during transportation. Lock the head in the horizontal position for transport by sliding the tilt lock lever to the locked position. The position of the tilt lock lever is shown in Figure 2 on page 11.

When the fixture is not installed, disconnect it from power and store it in a dry location.

6. Control menus and LCD display



Warning! DMX control is disabled when the control menus are active. Be prepared for the head to tilt and for the fixture to emit strong light as soon as you exit the control menus.

The control panel and LCD display provide access to user settings, readouts and utilities, including manual control and a test routine.

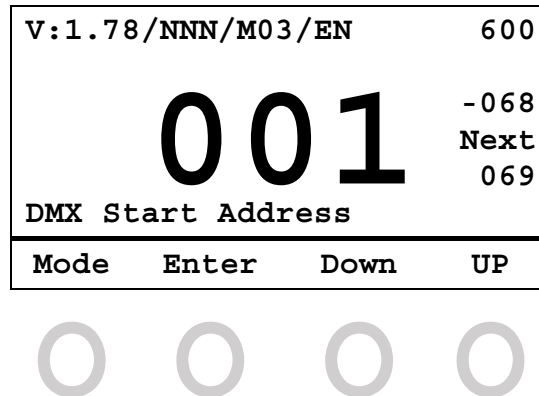

Figure 11. Main menu

See Figure 11. From left to right, the top line of the main menu displays:

- Main CPU software version
- DMX control modes for tilt, all pixels orientation and Plate 2 pixels orientation: N(ormal) or I(nverted)
- DMX mode number
- Dimming mode: L(inear), S(off), or E(xtra Soft)
- Flash mode: N(ormal) or (P)ercentage
- PWM frequency in Hz

For example, if the top line reads “**V:1.78/NNN/M03/EN/600**”, then:

- The main CPU software is version **1.78**,
- DMX control of tilt is set to **Normal**, Plate pixels orientation is set to **Normal**, and 2nd Plate pixels orientation is set to **Normal**,
- DMX mode 3 (**M03**) is selected,
- Dimming mode is set to **Extra soft**,
- Flash mode is set to **Normal**, and
- PWM frequency is set to **600** Hz.

The fixture also displays its DMX start address and indicates which DMX channels it uses and which DMX channel is available as the start address for the next fixture on the DMX link.

When the fixture boots up, the panel displays fixture information including component firmware and hardware versions and fixture hours before displaying the PCB reset status screen. After resetting, the panel displays the main menu.

The bottom row of the display shows the functions of the four control buttons. Press the **Mode** button to escape and return to the top of the menu. Press the **Enter** button to select a setting, issue a command, or enter a submenu. Press the **Down** and **Up** buttons to scroll through menu options.

To return resettable counters to zero, press and hold **Enter** for 3 seconds with the counter displayed.

DMX control is disabled when the control menus are active.

A flashing display indicates loss of DMX.

7. Control menu layout

Menu Selection		Value	Remarks
DMX Start Address		1-512	Set the DMX start address
Setup			
DMX Mode			
	M01 COMPRESS	-	Compressed 14-channel mode
	M02 NORMAL	-	Normal 23-channel mode
	M03 SPIX	-	High resolution 68-channel mode
	M04 SPIXPRO	-	High resolution 62-channel mode
	M05 1PIXPRO	-	Low resolution 17-channel mode
	M06 EASY	-	Low resolution 11-channel mode
Settings			
Tilt			
	Invert Tilt	ON/OFF	Invert tilt control
	Reset Tilt	ON/OFF	If set to OFF, tilt movement will not reset if fixture resets
	Position Feedback	ON/OFF	Enable/disable tilt position feedback
	Barndoor	ON/OFF	Reduces tilt speed to protect barndoors etc.
	Tilt Enable	ON	Tilt enabled and DMX controllable
		OFF	Tilt disabled
		NC	Tilt enabled, not DMX controllable
Shutter			
	Error Blackout	ON/OFF	Blackout if internal error detected
	No DMX Blackout	ON/OFF	Blackout if no DMX for 3 seconds
Init Positions			
	Save	-	Save as initial positions
	Reset	-	Restore default positions
Dimming Curve			
	Linear	-	Select dimming curve
	Soft	-	
	Extra Soft	-	
DMX Hold			Behavior if no DMX signal received
	Off	-	Blackout on loss of DMX
	Fade Out	-	Fade out on loss of DMX
	Hold	-	Hold state on loss of DMX
PWM Frequency			Adjust PWM frequency for all LEDs
	582-618 Hz	-	Default = 600 Hz
	1200 Hz	-	
	2400 Hz	-	
	Pixel Orientation	INVRS/ NORM	Numbering of all plate and all beam pixels (OFF = normal, ON = inverted)
	Second Pixel Orientation	INVRS/ NORM	Numbering of plate pixels 7-12 only (OFF = normal, ON = inverted)

	Flash Mode	PCT	Percentage flash mode
		NORM	Normal flash mode
		AGGER	Aggressive flash mode
	Dimmer Flash	ON/OFF	Dimmer Flash mode
	Plate Color Priority	Strobe Color	FX patterns and flashes use Plate FX/flash color
		Color Mix	FX patterns and flashes use mix of Plate FX/flash color and background color if a background color is active
		Back-ground color	FX patterns and flashes uses Plate background color if a background color is active
	Display		Adjust control panel display
	Contrast	0-100%	Default = 50%
	Brightness	0-100%	Default = 100%
	Blackout Time	1-30 s	Display sleep (seconds after last keypress) Default = 10 s
	Display Orientation	Normal	Normal display
		Inverted	Inverted display
	No DMX Flash	ON/OFF	Display flashes if loss of DMX
	Temperature Unit	°C/°F	
	Fan Mode		
	Auto	-	Temperature-controlled fan speed
	High	-	Maximum cooling
	Reset Factory Settings	Yes/No	Reset all values except serial number
Information			
	System Errors	List	Display recent errors
	System Versions		
	Main	SW/HW	Display software and hardware versions in the fixture's modules
	Tilt	SW/HW	
	NM-LED A	SW/HW	
	NM-LED B	SW/HW	
	NM-LED C	SW/HW	
	NM-LED D	SW/HW	
	Temperatures		
	Main Temperature		
	Current	°C/°F	Current base temperature
	Max. Resettable	°C/°F	Max. temperature since last reset
	Max. Non-resettable	°C/°F	All time maximum temperature
	LED Temperature		
	Current	°C/°F	Current LED temperature
	Max. Resettable	°C/°F	Max. LED temperature since last reset
	Max. Non-resettable	°C/°F	All time maximum LED temperature
	Fixture Information		
	Fixture Hours		
	Total hours	hours	Total hours of operation
	Resettable hours	hours	Hours of operation since last reset
	Boot Count	count	Total number of power-ons

	Fixture Status		
	Power State	BAT/PO	Fixture on battery or AC mains power
	DMX Input Monitor		
	Tilt	0-255	Shows current DMX values for each effect
	Special / Control	0-255	
	Beam FX Shutter	0-255	
	Beam Dimmer	0-255	
	Beam Duration	0-255	
	Beam Rate	0-255	
	Color Shutter	0-255	
	FX Color Dimmer	0-255	
	Color Duration	0-255	
	Color Rate	0-255	
	Plate Red	0-255	
	Plate Green	0-255	
	Plate Blue	0-255	
	FX Crossfade	0-255	
	Pattern Color Movement	0-255	
	Pattern Select Color	0-255	
	Pattern Beam Movement	0-255	
	Pattern Select Beam	0-255	
	Master Pix Intensity	0-255	
	Fans Monitor		
	PSU Fan	RPM/V	Shows fan speed and voltage
	Head Fan	RPM/V	
	Manual Control		
	Reset		
	Full System Reset	YES/NO	Reset options
	Tilt Reset	YES/NO	
	NM_LED L Driver	YES/NO	
	NM_LED R Driver	YES/NO	
	Manual DMX		
	Tilt	0-255	Enter control values to control each effect (new values received via DMX override manually entered values)
	Special / Control	0-255	
	Beam FX Shutter	0-255	
	Beam Dimmer	0-255	
	Beam Duration	0-255	
	Beam Rate	0-255	
	Color Shutter	0-255	
	Color Dimmer	0-255	
	Color Duration	0-255	
	Color Rate	0-255	
	FX Color Dimmer	0-255	
	Plate Red	0-255	
	Plate Green	0-255	
	Plate Blue	0-255	
	FX Crossfade	0-255	
	Pattern Color Movement	0-255	

	Pattern Select Color	0-255	Enter control values to control each effect (new values received via DMX override manually entered values)
	Pattern Beam Movement	0-255	
	Pattern Select Beam	0-255	
	Master Pix Intensity	0-255	
	Reset All Values	YES/NO	
Test			
	Tilt	ON/OFF	Run test of functions
	Color	ON/OFF	
	All	ON/OFF	
Service	Reserved for GLP Service		

Table 1 Control Menus

Default settings are written in **BOLD type**.

8. DMX channels

The JDC1 can be operated in six different DMX modes that use from 14 to 68 channels. The commands for each mode are listed in the following tables.

The layout of channels 1-7 is the same in each mode.

Where commands are marked with an asterisk * you must start from DMX value zero and then send the DMX value continuously for 3 seconds (unless a different duration is stated) to apply the command.

DMX Mode 1 (Compressed Pro), 14 DMX Channels
Tilt, Beam shutter, special/control, Plates shutter, Plates grouped RGB

Channel	Command	DMX range	Percent	Default DMX	Fade	
1	Coarse Tilt (MSB)	0-185°	0-255	0-100%	127	Fade
2	Fine Tilt (LSB)	Coarse tilt + 0-1.2°	0-255	0-100%	127	Fade
3	Beam Intensity	Intensity 0-100%	0-255	0-100%	0	Fade
4	Beam Duration	Flash duration 7-650 ms	0-255	0-100%	255	Fade
5	Beam Rate	Flash rate 0.289-16.67 Hz	0-255	0-100%	255	Fade
6	Beam Shutter	No effect	0-36	0-14.0%	0	Snap
		Ramp up (= fade on, snap off)	37-40	14.5-15.5%		
		Ramp up random	41-44	16.0-17.0%		
		Ramp down	45-48	17.5-18.5%		
		Ramp down random	49-52	19.0-20.0%		
		Ramp up down	53-56	20.5-21.5%		
		Ramp up down random	57-60	22.0-23.0%		
		Random white beam	61-64	23.5-24.5%		
		Random single pixel of white beam	65-68	25.0-26.0%		
		Lightning	69-72	26.5-27.5%		
		Spikes (flash over low light)	73-76	28.0-29.0%		
		White beam, left to right	77-80	30.0-31.5%		
		White beam, left to right, random	81-84	32.0-33.0%		
		White beam, right to left	85-88	33.5-34.5%		
		White beam, right to left, random	89-92	35.0-36.0%		
		White beam, left to right, bounce	93-96	36.5-37.5%		
		White beam, left to right, bounce, random	97-100	38.0-39.0%		
		White beam, right to left, bounce	101-104	39.5-40.5%		
		White beam, right to left, bounce, random	105-108	41.0-42.5%		
		Zig, 6 steps, outer to center pixels	109-112	43.0-43.5%		
		Zig, 6 steps, outer to center pixels random	113-116	44.0-45.5%		
		Zag, 6 steps, center to outer pixels	117-120	46.0-47.0%		
		Zag, 6 steps, center to outer pixels, random	121-124	47.5-48.5%		
		Zigzag, 10 steps	125-128	49.0-50.0%		
		Zigzag, 10 steps, random	129-132	50.5-52.0%		
		No function	133-179	52.5-70.0%		
		Double flash	180-183	70.6-71.8%		
		Double flash, random	184-187	72.2-73.3%		
		Double flash, b-c (beam-color)	188-191	73.7-74.9%		
		Double flash, b-c, random	192-195	75.3-76.5%		
		Double flash, c-b (color-beam)	196-199	76.9-78.0%		
		Double flash, c-b, random	200-203	78.4-79.6%		
		Triple flash	204-207	80.0-81.2%		
Triple flash, random	208-211	81.6-82.7%				
Triple flash, beam-color-beam	212-215	83.1-84.3%				
Triple flash, b-c-b, random	216-219	84.7-85.9%				
Triple flash, c-b-c	220-223	86.3-87.5%				
Triple flash, c-b-c, random	224-227	87.8-89.0%				

6	Beam Shutter (continued)	Quad flash	228-231	89.4-90.6%		
		Quad flash, random	232-235	91.0-92.2%		
		Quad flash, b-c-b-c	236-239	92.5-93.7%		
		Quad flash, b-c-b-c, random	240-243	94.1-95.3%		
		Quad flash, c-b-c-b	244-247	95.7-96.9%		
		Quad flash, c-b-c-b, random	248-251	97.3-98.4%		
		No function	252-255	98.5-100%		
7	Special / Control	No function	0	0%	0	Snap
		Beam Shutter effects and FX patterns offset:				
		10°	1	0.4%		
		20°	2	0.8%		
		30°	3	1.2%		
		40°	4	1.6%		
		50°	5	2.0%		
		60°	6	2.4%		
		70°	7	2.8%		
		80°	8	3.1%		
		90°	9	3.5%		
		100°	10	3.9%		
		110°	11	4.3%		
		120°	12	4.7%		
		130°	13	5.1%		
		140°	14	5.5%		
		150°	15	5.9%		
		160°	16	6.3%		
		170°	17	6.7%		
		180°	18	7.1%		
		190°	19	7.5%		
		200°	20	7.8%		
		210°	21	8.2%		
		220°	22	8.6%		
		230°	23	9.0%		
		240°	24	9.4%		
		250°	25	9.8%		
		260°	26	10.2%		
		270°	27	10.6%		
		280°	28	11.0%		
		290°	29	11.4%		
		300°	30	11.8%		
		310°	31	12.2%		
		320°	32	12.6%		
		330°	33	12.9%		
		340°	34	13.3%		
		350°	35	13.7%		
360°	36	14.1%				
No function	37-39	14.5-15.3%				

7	Special / Control (continued)	Position feedback on*	40-44	15.7-17.3%		
		Position feedback off*	45-49	17.7-19.2%		
		Barndoor on*	50-54	19.6-21.2%		
		Barndoor off*	55-59	21.6-23.1%		
		No function	60-61	23.5-23.9%		
		Tilt power on*	62-63	24.3-24.7%		
		Tilt power off*	64-65	25.1-25.5%		
		Tilt reset on*	66-67	25.9-26.3%		
		Tilt reset off*	68-69	26.7-27.1%		
		Normal tilt control*	70-74	27.5-29.0%		
		Inverse tilt control*	75-79	29.4-31.0%		
		Normal pixel numbering, plates 1+2	80-84	31.4-32.9%		
		Inverse pixel numbering, plates 1+2	85-89	33.3-34.9%		
		Normal pixel numbering, 2nd plate	90-94	35.3-36.9%		
		Inverse pixel numbering, 2nd plate	95-99	37.3-38.8%		
		Linear dimming curve	100-101	39.2-39.6%		
		Soft dimming curve	102-103	40.0-40.4%		
		Extra-soft dimming curve	104-105	40.8-41.2%		
		No function	106-120	41.6-47.1%		
		PWM frequency (hold value for >3 seconds):				
		582 Hz	121-122	47.5-47.8%		
		583 Hz	123-124	48.2-48.6%		
		584 Hz	125-126	49.0-49.4%		
		585 Hz	127-128	49.8-50.2%		
		586 Hz	129-130	50.6-51.0%		
		587 Hz	131-132	51.4-51.8%		
		588 Hz	133-134	52.2-52.5%		
		589 Hz	135-136	52.9-53.3%		
		590 Hz	137-138	53.7-54.1%		
		591 Hz	139-140	54.5-54.9%		
		592 Hz	141-142	55.3-55.7%		
		593 Hz	143-144	56.1-56.5%		
		594 Hz	145-146	56.9-57.3%		
		595 Hz	147-148	57.6-58.0%		
		596 Hz	149-150	58.4-58.8%		
		597 Hz	151-152	59.2-59.6%		
		598 Hz	153-154	60.0-60.4%		
		599 Hz	155-156	60.8-61.2%		
		600 Hz	157-158	61.6-62.0%		
		601 Hz	159-160	62.4-62.7%		
		602 Hz	161-162	63.1-63.5%		
		603 Hz	163-164	63.9-64.3%		
		604 Hz	165-166	64.7-65.1%		
		605 Hz	167-168	65.5-65.9%		
		606 Hz	169-170	66.3-66.7%		
		607 Hz	171-172	67.1-67.5%		
		608 Hz	173-174	67.8-68.2%		
609 Hz	175-176	68.6-69.0%				
610 Hz	177-178	69.4-69.8%				
611 Hz	179-180	70.2-70.6%				

7	Special /Control (continued)	612 Hz	181-182	71.0-71.4%		
		613 Hz	183-184	71.8-72.2%		
		614 Hz	185-186	72.5-72.9%		
		615 Hz	187-188	73.3-73.7%		
		616 Hz	189-190	74.1-74.5%		
		617 Hz	191-192	74.9-75.3%		
		618 Hz	193-194	75.6-76.1%		
		1200 Hz	195-197	76.5-77.3%		
		2400 Hz	198-200	77.6-78.4%		
		Fan mode = Auto	201-204	78.8-80.0%		
		Fan mode = High	205-209	80.4-82.0%		
		Percentage flash mode (hold for >0.5 sec.)	210-214	82.5-84.0%		
		Normal flash mode (hold for >0.5 sec.)	215-219	84.5-85.0%		
		Dimmer flash mode on*	220-224	86.0-87.5%		
		Dimmer flash mode off*	225-229	88.0-90.0%		
		FX color priority = Beam*	230-233	90.5-91.4%		
		FX color priority = Mixed*	234-236	91.8-92.5%		
		FX color priority = Plate*	237-239	92.9-93.7%		
Aggressive flash mode (hold for >0.5 sec.)	240-244	94.1-95.7%				
No function	245-247	96.1-96.9%				
Reset (hold value for >5 sec.)	248-255	97.3-100%				
8	Plate Intensity	Intensity 0-100%	0-255	0-100%	0	Fade
9	Plate Flash Duration	7-650 ms	0-255	0-100%	255	Fade
10	Plate Flash Rate	0.289-16.67 Hz	0-255	0-100%	255	Fade
11	Plate Shutter	No function	0	0%	0	Snap
		Plate Shutter effects and FX patterns offset:				
		10°	1	0.4%		
		20°	2	0.8%		
		30°	3	1.2%		
		40°	4	1.6%		
		50°	5	2.0%		
		60°	6	2.4%		
		70°	7	2.8%		
		80°	8	3.1%		
		90°	9	3.5%		
		100°	10	3.9%		
		110°	11	4.3%		
		120°	12	4.7%		
		130°	13	5.1%		
		140°	14	5.5%		
		150°	15	5.9%		
		160°	16	6.3%		
		170°	17	6.7%		
		180°	18	7.1%		
		190°	19	7.5%		
		200°	20	7.8%		
210°	21	8.2%				
220°	22	8.6%				

11	Plate Shutter (continued)	240°	24	9.4%		
		250°	25	9.8%		
		260°	26	10.2%		
		270°	27	10.6%		
		280°	28	11.0%		
		290°	29	11.4%		
		300°	30	11.8%		
		310°	31	12.2%		
		320°	32	12.6%		
		330°	33	12.9%		
		340°	34	13.3%		
		350°	35	13.7%		
		360°	36	14.1%		
		Ramp up (fade on, snap off)	37-40	14.5-15.5%		
		Ramp up, random	41-44	16.0-17.0%		
		Ramp down	45-48	17.5-18.5%		
		Ramp down, random	49-52	19.0-20.0%		
		Ramp up / down	53-56	20.5-21.5%		
		Ramp up / down, random	57-60	22.0-23.0%		
		Random white beam	61-64	23.5-24.5%		
		Random single pixel in white beam	65-68	25.0-26.0%		
		Lightning	69-72	26.5-27.5%		
		Spikes (flash over low light)	73-76	28.0-29.0%		
		No function	77-179	29.5-70.0%		
		Double flash	180-191	70.6-74.9%		
		Double flash, random	192-203	75.3-79.6%		
		Triple flash	204-215	80.0-84.3%		
Triple flash, random	216-227	84.7-89.0%				
Quad flash	228-239	89.4-93.7%				
Quad flash, random	240-251	94.1-98.4%				
No effect	252-255	98.5-100%				
12	Plates Red	Plates red intensity 0-100%	0-255	0-100%	255	Fade
13	Plates Green	Plates green intensity 0-100%	0-255	0-100%	255	Fade
14	Plates Blue	Plates blue intensity 0-100%	0-255	0-100%	255	Fade

DMX Mode 2 (Normal), 23 DMX Channels

Tilt, Beam shutter, special/control, Plates shutter, Plates grouped RGB, Plate and Beam FX, Plates background grouped RGB

Channel	Command	DMX range	Percent	Default DMX	Fade	
1	Coarse Tilt (MSB)	0-185°	0-255	0-100%	127	Fade
2	Fine Tilt (LSB)	Coarse tilt + 0-1.2°	0-255	0-100%	127	Fade
3	Beam Intensity	Intensity 0-100%	0-255	0-100%	0	Fade
4	Beam Duration	Flash duration 7-650 ms	0-255	0-100%	255	Fade
5	Beam Rate	Flash rate 0.289-16.67 Hz	0-255	0-100%	255	Fade
6	Beam Shutter	No effect	0-36	0-14.0%	0	Snap
		Ramp up (= fade on, snap off)	37-40	14.5-15.5%		
		Ramp up random	41-44	16.0-17.0%		
		Ramp down	45-48	17.5-18.5%		
		Ramp down random	49-52	19.0-20.0%		
		Ramp up down	53-56	20.5-21.5%		
		Ramp up down random	57-60	22.0-23.0%		
		Random white beam	61-64	23.5-24.5%		
		Random single pixel of white beam	65-68	25.0-26.0%		
		Lightning	69-72	26.5-27.5%		
		Spikes (flash over low light)	73-76	28.0-29.0%		
		White beam, left to right	77-80	30.0-31.5%		
		White beam, left to right, random	81-84	32.0-33.0%		
		White beam, right to left	85-88	33.5-34.5%		
		White beam, right to left, random	89-92	35.0-36.0%		
		White beam, left to right, bounce	93-96	36.5-37.5%		
		White beam, left to right, bounce, random	97-100	38.0-39.0%		
		White beam, right to left, bounce	101-104	39.5-40.5%		
		White beam, right to left, bounce, random	105-108	41.0-42.5%		
		Zig, 6 steps, outer to center pixels	109-112	43.0-43.5%		
		Zig, 6 steps, outer to center pixels random	113-116	44.0-45.5%		
		Zag, 6 steps, center to outer pixels	117-120	46.0-47.0%		
		Zag, 6 steps, center to outer pixels, random	121-124	47.5-48.5%		
		Zigzag, 10 steps	125-128	49.0-50.0%		
		Zigzag, 10 steps, random	129-132	50.5-52.0%		
		No function	133-179	52.5-70.0%		
		Double flash	180-183	70.6-71.8%		
		Double flash, random	184-187	72.2-73.3%		
		Double flash, b-c (beam-color)	188-191	73.7-74.9%		
		Double flash, b-c, random	192-195	75.3-76.5%		
		Double flash, c-b (color-beam)	196-199	76.9-78.0%		
		Double flash, c-b, random	200-203	78.4-79.6%		
Triple flash	204-207	80.0-81.2%				
Triple flash, random	208-211	81.6-82.7%				
Triple flash, beam-color-beam	212-215	83.1-84.3%				
Triple flash, b-c-b, random	216-219	84.7-85.9%				
Triple flash, c-b-c	220-223	86.3-87.5%				
Triple flash, c-b-c, random	224-227	87.8-89.0%				

6	Beam Shutter (continued)	Quad flash	228-231	89.4-90.6%		
		Quad flash, random	232-235	91.0-92.2%		
		Quad flash, b-c-b-c	236-239	92.5-93.7%		
		Quad flash, b-c-b-c, random	240-243	94.1-95.3%		
		Quad flash, c-b-c-b	244-247	95.7-96.9%		
		Quad flash, c-b-c-b, random	248-251	97.3-98.4%		
		No function	252-255	98.5-100%		
7	Special / Control	No function	0	0%	0	Snap
		Beam Shutter effects and FX patterns offset:				
		10°	1	0.4%		
		20°	2	0.8%		
		30°	3	1.2%		
		40°	4	1.6%		
		50°	5	2.0%		
		60°	6	2.4%		
		70°	7	2.8%		
		80°	8	3.1%		
		90°	9	3.5%		
		100°	10	3.9%		
		110°	11	4.3%		
		120°	12	4.7%		
		130°	13	5.1%		
		140°	14	5.5%		
		150°	15	5.9%		
		160°	16	6.3%		
		170°	17	6.7%		
		180°	18	7.1%		
		190°	19	7.5%		
		200°	20	7.8%		
		210°	21	8.2%		
		220°	22	8.6%		
		230°	23	9.0%		
		240°	24	9.4%		
		250°	25	9.8%		
		260°	26	10.2%		
		270°	27	10.6%		
		280°	28	11.0%		
		290°	29	11.4%		
		300°	30	11.8%		
		310°	31	12.2%		
		320°	32	12.6%		
		330°	33	12.9%		
		340°	34	13.3%		
		350°	35	13.7%		
360°	36	14.1%				
No function	37-39	14.5-15.3%				

7	Special / Control (continued)	Position feedback on*	40-44	15.7-17.3%		
		Position feedback off*	45-49	17.7-19.2%		
		Barndoor on*	50-54	19.6-21.2%		
		Barndoor off*	55-59	21.6-23.1%		
		No function	60-61	23.5-23.9%		
		Tilt power on*	62-63	24.3-24.7%		
		Tilt power off*	64-65	25.1-25.5%		
		Tilt reset on*	66-67	25.9-26.3%		
		Tilt reset off*	68-69	26.7-27.1%		
		Normal tilt control*	70-74	27.5-29.0%		
		Inverse tilt control*	75-79	29.4-31.0%		
		Normal pixel numbering, plates 1+2	80-84	31.4-32.9%		
		Inverse pixel numbering, plates 1+2	85-89	33.3-34.9%		
		Normal pixel numbering, 2nd plate	90-94	35.3-36.9%		
		Inverse pixel numbering, 2nd plate	95-99	37.3-38.8%		
		Linear dimming curve	100-101	39.2-39.6%		
		Soft dimming curve	102-103	40.0-40.4%		
		Extra-soft dimming curve	104-105	40.8-41.2%		
		No function	106-120	41.6-47.1%		
		PWM frequency (hold value for >3 seconds):				
		582 Hz	121-122	47.5-47.8%		
		583 Hz	123-124	48.2-48.6%		
		584 Hz	125-126	49.0-49.4%		
		585 Hz	127-128	49.8-50.2%		
		586 Hz	129-130	50.6-51.0%		
		587 Hz	131-132	51.4-51.8%		
		588 Hz	133-134	52.2-52.5%		
		589 Hz	135-136	52.9-53.3%		
		590 Hz	137-138	53.7-54.1%		
		591 Hz	139-140	54.5-54.9%		
		592 Hz	141-142	55.3-55.7%		
		593 Hz	143-144	56.1-56.5%		
		594 Hz	145-146	56.9-57.3%		
		595 Hz	147-148	57.6-58.0%		
		596 Hz	149-150	58.4-58.8%		
		597 Hz	151-152	59.2-59.6%		
		598 Hz	153-154	60.0-60.4%		
		599 Hz	155-156	60.8-61.2%		
		600 Hz	157-158	61.6-62.0%		
		601 Hz	159-160	62.4-62.7%		
		602 Hz	161-162	63.1-63.5%		
		603 Hz	163-164	63.9-64.3%		
		604 Hz	165-166	64.7-65.1%		
		605 Hz	167-168	65.5-65.9%		
		606 Hz	169-170	66.3-66.7%		
		607 Hz	171-172	67.1-67.5%		
608 Hz	173-174	67.8-68.2%				
609 Hz	175-176	68.6-69.0%				
610 Hz	177-178	69.4-69.8%				
611 Hz	179-180	70.2-70.6%				

7	Special /Control (continued)	612 Hz	181-182	71.0-71.4%		
		613 Hz	183-184	71.8-72.2%		
		614 Hz	185-186	72.5-72.9%		
		615 Hz	187-188	73.3-73.7%		
		616 Hz	189-190	74.1-74.5%		
		617 Hz	191-192	74.9-75.3%		
		618 Hz	193-194	75.6-76.1%		
		1200 Hz	195-197	76.5-77.3%		
		2400 Hz	198-200	77.6-78.4%		
		Fan mode = Auto	201-204	78.8-80.0%		
		Fan mode = High	205-209	80.4-82.0%		
		Percentage flash mode (hold for >0.5 sec.)	210-214	82.5-84.0%		
		Normal flash mode (hold for >0.5 sec.)	215-219	84.5-85.0%		
		Dimmer flash mode on*	220-224	86.0-87.5%		
		Dimmer flash mode off*	225-229	88.0-90.0%		
		FX color priority = Beam*	230-233	90.5-91.4%		
		FX color priority = Mixed*	234-236	91.8-92.5%		
		FX color priority = Plate*	237-239	92.9-93.7%		
Aggressive flash mode (hold for >0.5 sec.)	240-244	94.1-95.7%				
No function	245-247	96.1-96.9%				
Reset (hold value for >5 sec.)	248-255	97.3-100%				
8	Plate Intensity	Intensity 0-100%	0-255	0-100%	0	Fade
9	Plate Flash Duration	7-650 ms	0-255	0-100%	255	Fade
10	Plate Flash Rate	0.289-16.67 Hz	0-255	0-100%	255	Fade
11	Plate Shutter	No function	0	0%	0	Snap
		Plate Shutter effects and FX patterns offset:				
		10°	1	0.4%		
		20°	2	0.8%		
		30°	3	1.2%		
		40°	4	1.6%		
		50°	5	2.0%		
		60°	6	2.4%		
		70°	7	2.8%		
		80°	8	3.1%		
		90°	9	3.5%		
		100°	10	3.9%		
		110°	11	4.3%		
		120°	12	4.7%		
		130°	13	5.1%		
		140°	14	5.5%		
		150°	15	5.9%		
		160°	16	6.3%		
		170°	17	6.7%		
		180°	18	7.1%		
		190°	19	7.5%		
		200°	20	7.8%		
210°	21	8.2%				
220°	22	8.6%				

11	Plate Shutter (continued)	240°	24	9.4%		
		250°	25	9.8%		
		260°	26	10.2%		
		270°	27	10.6%		
		280°	28	11.0%		
		290°	29	11.4%		
		300°	30	11.8%		
		310°	31	12.2%		
		320°	32	12.6%		
		330°	33	12.9%		
		340°	34	13.3%		
		350°	35	13.7%		
		360°	36	14.1%		
		Ramp up (fade on, snap off)	37-40	14.5-15.5%		
		Ramp up, random	41-44	16.0-17.0%		
		Ramp down	45-48	17.5-18.5%		
		Ramp down, random	49-52	19.0-20.0%		
		Ramp up / down	53-56	20.5-21.5%		
		Ramp up / down, random	57-60	22.0-23.0%		
		Random white beam	61-64	23.5-24.5%		
		Random single pixel in white beam	65-68	25.0-26.0%		
		Lightning	69-72	26.5-27.5%		
		Spikes (flash over low light)	73-76	28.0-29.0%		
		No function	77-179	29.5-70.0%		
		Double flash	180-191	70.6-74.9%		
		Double flash, random	192-203	75.3-79.6%		
Triple flash	204-215	80.0-84.3%				
Triple flash, random	216-227	84.7-89.0%				
Quad flash	228-239	89.4-93.7%				
Quad flash, random	240-251	94.1-98.4%				
No effect	252-255	98.5-100%				
12	Plates Red	Plates red intensity 0-100%	0-255	0-100%	255	Fade
13	Plates Green	Plates green intensity 0-100%	0-255	0-100%	255	Fade
14	Plates Blue	Plates blue intensity 0-100%	0-255	0-100%	255	Fade
15	FX Crossfade	Crossfade duration snap - slow	0-255	0-100%	0	Fade
16	Plate FX Movement	Plate FX movement speed slow - fast	0-255	0-100%	0	Snap
17	Plate FX Select	Plate FX pattern select	0-255	0-100%	0	Snap
18	Beam FX Movement	Beam FX movement speed slow - fast	0-255	0-100%	0	Snap
19	Beam FX Select	Beam FX pattern select	0-255	0-100%	0	Snap
20	Plates Master	FX background intensity 0-100%	0-255	0-100%	0	Fade
21	Plates Background Red	FX background intensity red 0-100%	0-255	0-100%	255	Fade
22	Plates Background Green	FX background intensity green 0-100%	0-255	0-100%	255	Fade
23	Plates Background Blue	FX background intensity blue 0-100%	0-255	0-100%	255	Fade

DMX Mode 3 (SPix), 68 DMX Channels

Tilt, Beam shutter, special/control, Plates shutter, Plates grouped RGB, Plate and Beam FX, Plate background individual pixel RGB, Beam individual pixel intensity

Channel	Command	DMX range	Percent	Default DMX	Fade	
1	Coarse Tilt (MSB)	0-185°	0-255	0-100%	127	Fade
2	Fine Tilt (LSB)	Coarse tilt + 0-1.2°	0-255	0-100%	127	Fade
3	Beam Intensity	Intensity 0-100%	0-255	0-100%	0	Fade
4	Beam Duration	Flash duration 7-650 ms	0-255	0-100%	255	Fade
5	Beam Rate	Flash rate 0.289-16.67 Hz	0-255	0-100%	255	Fade
6	Beam Shutter	No effect	0-36	0-14.0%	0	Snap
		Ramp up (= fade on, snap off)	37-40	14.5-15.5%		
		Ramp up random	41-44	16.0-17.0%		
		Ramp down	45-48	17.5-18.5%		
		Ramp down random	49-52	19.0-20.0%		
		Ramp up down	53-56	20.5-21.5%		
		Ramp up down random	57-60	22.0-23.0%		
		Random white beam	61-64	23.5-24.5%		
		Random single pixel of white beam	65-68	25.0-26.0%		
		Lightning	69-72	26.5-27.5%		
		Spikes (flash over low light)	73-76	28.0-29.0%		
		White beam, left to right	77-80	30.0-31.5%		
		White beam, left to right, random	81-84	32.0-33.0%		
		White beam, right to left	85-88	33.5-34.5%		
		White beam, right to left, random	89-92	35.0-36.0%		
		White beam, left to right, bounce	93-96	36.5-37.5%		
		White beam, left to right, bounce, random	97-100	38.0-39.0%		
		White beam, right to left, bounce	101-104	39.5-40.5%		
		White beam, right to left, bounce, random	105-108	41.0-42.5%		
		Zig, 6 steps, outer to center pixels	109-112	43.0-43.5%		
		Zig, 6 steps, outer to center pixels random	113-116	44.0-45.5%		
		Zag, 6 steps, center to outer pixels	117-120	46.0-47.0%		
		Zag, 6 steps, center to outer pixels, random	121-124	47.5-48.5%		
		Zigzag, 10 steps	125-128	49.0-50.0%		
		Zigzag, 10 steps, random	129-132	50.5-52.0%		
		No function	133-179	52.5-70.0%		
		Double flash	180-183	70.6-71.8%		
		Double flash, random	184-187	72.2-73.3%		
		Double flash, b-c (beam-color)	188-191	73.7-74.9%		
		Double flash, b-c, random	192-195	75.3-76.5%		
		Double flash, c-b (color-beam)	196-199	76.9-78.0%		
		Double flash, c-b, random	200-203	78.4-79.6%		
Triple flash	204-207	80.0-81.2%				
Triple flash, random	208-211	81.6-82.7%				
Triple flash, beam-color-beam	212-215	83.1-84.3%				
Triple flash, b-c-b, random	216-219	84.7-85.9%				
Triple flash, c-b-c	220-223	86.3-87.5%				
Triple flash, c-b-c, random	224-227	87.8-89.0%				

6	Beam Shutter (continued)	Quad flash	228-231	89.4-90.6%		
		Quad flash, random	232-235	91.0-92.2%		
		Quad flash, b-c-b-c	236-239	92.5-93.7%		
		Quad flash, b-c-b-c, random	240-243	94.1-95.3%		
		Quad flash, c-b-c-b	244-247	95.7-96.9%		
		Quad flash, c-b-c-b, random	248-251	97.3-98.4%		
		No function	252-255	98.5-100%		
7	Special / Control	No function	0	0%	0	Snap
		Beam Shutter effects and FX patterns offset:				
		10°	1	0.4%		
		20°	2	0.8%		
		30°	3	1.2%		
		40°	4	1.6%		
		50°	5	2.0%		
		60°	6	2.4%		
		70°	7	2.8%		
		80°	8	3.1%		
		90°	9	3.5%		
		100°	10	3.9%		
		110°	11	4.3%		
		120°	12	4.7%		
		130°	13	5.1%		
		140°	14	5.5%		
		150°	15	5.9%		
		160°	16	6.3%		
		170°	17	6.7%		
		180°	18	7.1%		
		190°	19	7.5%		
		200°	20	7.8%		
		210°	21	8.2%		
		220°	22	8.6%		
		230°	23	9.0%		
		240°	24	9.4%		
		250°	25	9.8%		
		260°	26	10.2%		
		270°	27	10.6%		
		280°	28	11.0%		
		290°	29	11.4%		
		300°	30	11.8%		
		310°	31	12.2%		
		320°	32	12.6%		
		330°	33	12.9%		
		340°	34	13.3%		
		350°	35	13.7%		
360°	36	14.1%				
No function	37-39	14.5-15.3%				

7	Special / Control (continued)	Position feedback on*	40-44	15.7-17.3%		
		Position feedback off*	45-49	17.7-19.2%		
		Barndoor on*	50-54	19.6-21.2%		
		Barndoor off*	55-59	21.6-23.1%		
		No function	60-61	23.5-23.9%		
		Tilt power on*	62-63	24.3-24.7%		
		Tilt power off*	64-65	25.1-25.5%		
		Tilt reset on*	66-67	25.9-26.3%		
		Tilt reset off*	68-69	26.7-27.1%		
		Normal tilt control*	70-74	27.5-29.0%		
		Inverse tilt control*	75-79	29.4-31.0%		
		Normal pixel numbering, plates 1+2	80-84	31.4-32.9%		
		Inverse pixel numbering, plates 1+2	85-89	33.3-34.9%		
		Normal pixel numbering, 2nd plate	90-94	35.3-36.9%		
		Inverse pixel numbering, 2nd plate	95-99	37.3-38.8%		
		Linear dimming curve	100-101	39.2-39.6%		
		Soft dimming curve	102-103	40.0-40.4%		
		Extra-soft dimming curve	104-105	40.8-41.2%		
		No function	106-120	41.6-47.1%		
		PWM frequency (hold value for >3 seconds):				
		582 Hz	121-122	47.5-47.8%		
		583 Hz	123-124	48.2-48.6%		
		584 Hz	125-126	49.0-49.4%		
		585 Hz	127-128	49.8-50.2%		
		586 Hz	129-130	50.6-51.0%		
		587 Hz	131-132	51.4-51.8%		
		588 Hz	133-134	52.2-52.5%		
		589 Hz	135-136	52.9-53.3%		
		590 Hz	137-138	53.7-54.1%		
		591 Hz	139-140	54.5-54.9%		
		592 Hz	141-142	55.3-55.7%		
		593 Hz	143-144	56.1-56.5%		
		594 Hz	145-146	56.9-57.3%		
		595 Hz	147-148	57.6-58.0%		
		596 Hz	149-150	58.4-58.8%		
		597 Hz	151-152	59.2-59.6%		
		598 Hz	153-154	60.0-60.4%		
		599 Hz	155-156	60.8-61.2%		
		600 Hz	157-158	61.6-62.0%		
		601 Hz	159-160	62.4-62.7%		
		602 Hz	161-162	63.1-63.5%		
		603 Hz	163-164	63.9-64.3%		
		604 Hz	165-166	64.7-65.1%		
		605 Hz	167-168	65.5-65.9%		
		606 Hz	169-170	66.3-66.7%		
		607 Hz	171-172	67.1-67.5%		
		608 Hz	173-174	67.8-68.2%		
609 Hz	175-176	68.6-69.0%				
610 Hz	177-178	69.4-69.8%				
611 Hz	179-180	70.2-70.6%				

7	Special /Control (continued)	612 Hz	181-182	71.0-71.4%		
		613 Hz	183-184	71.8-72.2%		
		614 Hz	185-186	72.5-72.9%		
		615 Hz	187-188	73.3-73.7%		
		616 Hz	189-190	74.1-74.5%		
		617 Hz	191-192	74.9-75.3%		
		618 Hz	193-194	75.6-76.1%		
		1200 Hz	195-197	76.5-77.3%		
		2400 Hz	198-200	77.6-78.4%		
		Fan mode = Auto	201-204	78.8-80.0%		
		Fan mode = High	205-209	80.4-82.0%		
		Percentage flash mode (hold for >0.5 sec.)	210-214	82.5-84.0%		
		Normal flash mode (hold for >0.5 sec.)	215-219	84.5-85.0%		
		Dimmer flash mode on*	220-224	86.0-87.5%		
		Dimmer flash mode off*	225-229	88.0-90.0%		
		FX color priority = Beam*	230-233	90.5-91.4%		
		FX color priority = Mixed*	234-236	91.8-92.5%		
		FX color priority = Plate*	237-239	92.9-93.7%		
Aggressive flash mode (hold for >0.5 sec.)	240-244	94.1-95.7%				
No function	245-247	96.1-96.9%				
Reset (hold value for >5 sec.)	248-255	97.3-100%				
8	Plate Intensity	Intensity 0-100%	0-255	0-100%	0	Fade
9	Plate Flash Duration	7-650 ms	0-255	0-100%	255	Fade
10	Plate Flash Rate	0.289-16.67 Hz	0-255	0-100%	255	Fade
11	Plate Shutter	No function	0	0%	0	Snap
		Plate Shutter effects and FX patterns offset:				
		10°	1	0.4%		
		20°	2	0.8%		
		30°	3	1.2%		
		40°	4	1.6%		
		50°	5	2.0%		
		60°	6	2.4%		
		70°	7	2.8%		
		80°	8	3.1%		
		90°	9	3.5%		
		100°	10	3.9%		
		110°	11	4.3%		
		120°	12	4.7%		
		130°	13	5.1%		
		140°	14	5.5%		
		150°	15	5.9%		
		160°	16	6.3%		
		170°	17	6.7%		
		180°	18	7.1%		
		190°	19	7.5%		
		200°	20	7.8%		
210°	21	8.2%				
220°	22	8.6%				

11	Plate Shutter (continued)	240°	24	9.4%		
		250°	25	9.8%		
		260°	26	10.2%		
		270°	27	10.6%		
		280°	28	11.0%		
		290°	29	11.4%		
		300°	30	11.8%		
		310°	31	12.2%		
		320°	32	12.6%		
		330°	33	12.9%		
		340°	34	13.3%		
		350°	35	13.7%		
		360°	36	14.1%		
		Ramp up (fade on, snap off)	37-40	14.5-15.5%		
		Ramp up, random	41-44	16.0-17.0%		
		Ramp down	45-48	17.5-18.5%		
		Ramp down, random	49-52	19.0-20.0%		
		Ramp up / down	53-56	20.5-21.5%		
		Ramp up / down, random	57-60	22.0-23.0%		
		Random white beam	61-64	23.5-24.5%		
		Random single pixel in white beam	65-68	25.0-26.0%		
		Lightning	69-72	26.5-27.5%		
		Spikes (flash over low light)	73-76	28.0-29.0%		
		No function	77-179	29.5-70.0%		
		Double flash	180-191	70.6-74.9%		
		Double flash, random	192-203	75.3-79.6%		
Triple flash	204-215	80.0-84.3%				
Triple flash, random	216-227	84.7-89.0%				
Quad flash	228-239	89.4-93.7%				
Quad flash, random	240-251	94.1-98.4%				
No effect	252-255	98.5-100%				
12	Plates Red	Plates red intensity 0-100%	0-255	0-100%	255	Fade
13	Plates Green	Plates green intensity 0-100%	0-255	0-100%	255	Fade
14	Plates Blue	Plates blue intensity 0-100%	0-255	0-100%	255	Fade
15	FX Crossfade	Crossfade duration snap - slow	0-255	0-100%	0	Fade
16	Plate FX Movement	Plate FX movement speed slow - fast	0-255	0-100%	0	Fade
17	Plate FX Select	Plate FX pattern select	0-255	0-100%	0	Snap
18	Beam FX Movement	Beam FX movement speed slow - fast	0-255	0-100%	0	Fade
19	Beam FX Select	Beam FX pattern select	0-255	0-100%	0	Snap
20	Plate Master	FX background intensity 0-100%	0-255	0-100%	0	Fade
21	Plate Background Pixel 1	Red	0-100%	0-255	255	Fade
22		Green	0-100%	0-255	255	Fade
23		Blue	0-100%	0-255	255	Fade
24	Plate Background Pixel 2	Red	0-100%	0-255	255	Fade
25		Green	0-100%	0-255	255	Fade
26		Blue	0-100%	0-255	255	Fade
27	Plate Background Pixel 3	Red	0-100%	0-255	255	Fade
28		Green	0-100%	0-255	255	Fade
29		Blue	0-100%	0-255	255	Fade

30	Plate Background Pixel 4	Red	0-100%	0-255	255	Fade
31		Green	0-100%	0-255	255	Fade
32		Blue	0-100%	0-255	255	Fade
33	Plate Background Pixel 5	Red	0-100%	0-255	255	Fade
34		Green	0-100%	0-255	255	Fade
35		Blue	0-100%	0-255	255	Fade
36	Plate Background Pixel 6	Red	0-100%	0-255	255	Fade
37		Green	0-100%	0-255	255	Fade
38		Blue	0-100%	0-255	255	Fade
39	Plate Background Pixel 7	Red	0-100%	0-255	255	Fade
40		Green	0-100%	0-255	255	Fade
41		Blue	0-100%	0-255	255	Fade
42	Plate Background Pixel 8	Red	0-100%	0-255	255	Fade
43		Green	0-100%	0-255	255	Fade
44		Blue	0-100%	0-255	255	Fade
45	Plate Background Pixel 9	Red	0-100%	0-255	255	Fade
46		Green	0-100%	0-255	255	Fade
47		Blue	0-100%	0-255	255	Fade
48	Plate Background Pixel 10	Red	0-100%	0-255	255	Fade
49		Green	0-100%	0-255	255	Fade
50		Blue	0-100%	0-255	255	Fade
51	Plate Background Pixel 11	Red	0-100%	0-255	255	Fade
52		Green	0-100%	0-255	255	Fade
53		Blue	0-100%	0-255	255	Fade
54	Plate Background Pixel 12	Red	0-100%	0-255	255	Fade
55		Green	0-100%	0-255	255	Fade
56		Blue	0-100%	0-255	255	Fade
57	Beam Pixels Intensity	Pixel 1	0-100%	0-255	0	Fade
58		Pixel 2	0-100%	0-255	0	Fade
59		Pixel 3	0-100%	0-255	0	Fade
60		Pixel 4	0-100%	0-255	0	Fade
61		Pixel 5	0-100%	0-255	0	Fade
62		Pixel 6	0-100%	0-255	0	Fade
63		Pixel 7	0-100%	0-255	0	Fade
64		Pixel 8	0-100%	0-255	0	Fade
65		Pixel 9	0-100%	0-255	0	Fade
66		Pixel 10	0-100%	0-255	0	Fade
67		Pixel 11	0-100%	0-255	0	Fade
68		Pixel 12	0-100%	0-255	0	Fade

DMX Mode 4 (SPix Pro), 62 DMX Channels

Tilt, Beam shutter, special/control, Plates shutter, Plates grouped RGB, Plate individual pixel RGB, Beam individual pixel intensity

Channel	Command	DMX range	Percent	Default DMX	Fade	
1	Coarse Tilt (MSB)	0-185°	0-255	0-100%	127	Fade
2	Fine Tilt (LSB)	Coarse tilt + 0-1.2°	0-255	0-100%	127	Fade
3	Beam Intensity	Intensity 0-100%	0-255	0-100%	0	Fade
4	Beam Duration	Flash duration 7-650 ms	0-255	0-100%	255	Fade
5	Beam Rate	Flash rate 0.289-16.67 Hz	0-255	0-100%	255	Fade
6	Beam Shutter	No effect	0-36	0-14.0%	0	Snap
		Ramp up (= fade on, snap off)	37-40	14.5-15.5%		
		Ramp up random	41-44	16.0-17.0%		
		Ramp down	45-48	17.5-18.5%		
		Ramp down random	49-52	19.0-20.0%		
		Ramp up down	53-56	20.5-21.5%		
		Ramp up down random	57-60	22.0-23.0%		
		Random white beam	61-64	23.5-24.5%		
		Random single pixel of white beam	65-68	25.0-26.0%		
		Lightning	69-72	26.5-27.5%		
		Spikes (flash over low light)	73-76	28.0-29.0%		
		White beam, left to right	77-80	30.0-31.5%		
		White beam, left to right, random	81-84	32.0-33.0%		
		White beam, right to left	85-88	33.5-34.5%		
		White beam, right to left, random	89-92	35.0-36.0%		
		White beam, left to right, bounce	93-96	36.5-37.5%		
		White beam, left to right, bounce, random	97-100	38.0-39.0%		
		White beam, right to left, bounce	101-104	39.5-40.5%		
		White beam, right to left, bounce, random	105-108	41.0-42.5%		
		Zig, 6 steps, outer to center pixels	109-112	43.0-43.5%		
		Zig, 6 steps, outer to center pixels random	113-116	44.0-45.5%		
		Zag, 6 steps, center to outer pixels	117-120	46.0-47.0%		
		Zag, 6 steps, center to outer pixels, random	121-124	47.5-48.5%		
		Zigzag, 10 steps	125-128	49.0-50.0%		
		Zigzag, 10 steps, random	129-132	50.5-52.0%		
		No function	133-179	52.5-70.0%		
		Double flash	180-183	70.6-71.8%		
		Double flash, random	184-187	72.2-73.3%		
		Double flash, b-c (beam-color)	188-191	73.7-74.9%		
		Double flash, b-c, random	192-195	75.3-76.5%		
		Double flash, c-b (color-beam)	196-199	76.9-78.0%		
		Double flash, c-b, random	200-203	78.4-79.6%		
Triple flash	204-207	80.0-81.2%				
Triple flash, random	208-211	81.6-82.7%				
Triple flash, beam-color-beam	212-215	83.1-84.3%				
Triple flash, b-c-b, random	216-219	84.7-85.9%				
Triple flash, c-b-c	220-223	86.3-87.5%				
Triple flash, c-b-c, random	224-227	87.8-89.0%				

6	Beam Shutter (continued)	Quad flash	228-231	89.4-90.6%		
		Quad flash, random	232-235	91.0-92.2%		
		Quad flash, b-c-b-c	236-239	92.5-93.7%		
		Quad flash, b-c-b-c, random	240-243	94.1-95.3%		
		Quad flash, c-b-c-b	244-247	95.7-96.9%		
		Quad flash, c-b-c-b, random	248-251	97.3-98.4%		
		No function	252-255	98.5-100%		
7	Special / Control	No function	0	0%	0	Snap
		Beam Shutter effects and FX patterns offset:				
		10°	1	0.4%		
		20°	2	0.8%		
		30°	3	1.2%		
		40°	4	1.6%		
		50°	5	2.0%		
		60°	6	2.4%		
		70°	7	2.8%		
		80°	8	3.1%		
		90°	9	3.5%		
		100°	10	3.9%		
		110°	11	4.3%		
		120°	12	4.7%		
		130°	13	5.1%		
		140°	14	5.5%		
		150°	15	5.9%		
		160°	16	6.3%		
		170°	17	6.7%		
		180°	18	7.1%		
		190°	19	7.5%		
		200°	20	7.8%		
		210°	21	8.2%		
		220°	22	8.6%		
		230°	23	9.0%		
		240°	24	9.4%		
		250°	25	9.8%		
		260°	26	10.2%		
		270°	27	10.6%		
		280°	28	11.0%		
		290°	29	11.4%		
		300°	30	11.8%		
		310°	31	12.2%		
		320°	32	12.6%		
		330°	33	12.9%		
		340°	34	13.3%		
		350°	35	13.7%		
360°	36	14.1%				
No function	37-39	14.5-15.3%				

7	Special / Control (continued)	Position feedback on*	40-44	15.7-17.3%		
		Position feedback off*	45-49	17.7-19.2%		
		Barndoor on*	50-54	19.6-21.2%		
		Barndoor off*	55-59	21.6-23.1%		
		No function	60-61	23.5-23.9%		
		Tilt power on*	62-63	24.3-24.7%		
		Tilt power off*	64-65	25.1-25.5%		
		Tilt reset on*	66-67	25.9-26.3%		
		Tilt reset off*	68-69	26.7-27.1%		
		Normal tilt control*	70-74	27.5-29.0%		
		Inverse tilt control*	75-79	29.4-31.0%		
		Normal pixel numbering, plates 1+2	80-84	31.4-32.9%		
		Inverse pixel numbering, plates 1+2	85-89	33.3-34.9%		
		Normal pixel numbering, 2nd plate	90-94	35.3-36.9%		
		Inverse pixel numbering, 2nd plate	95-99	37.3-38.8%		
		Linear dimming curve	100-101	39.2-39.6%		
		Soft dimming curve	102-103	40.0-40.4%		
		Extra-soft dimming curve	104-105	40.8-41.2%		
		No function	106-120	41.6-47.1%		
		PWM frequency (hold value for >3 seconds):				
		582 Hz	121-122	47.5-47.8%		
		583 Hz	123-124	48.2-48.6%		
		584 Hz	125-126	49.0-49.4%		
		585 Hz	127-128	49.8-50.2%		
		586 Hz	129-130	50.6-51.0%		
		587 Hz	131-132	51.4-51.8%		
		588 Hz	133-134	52.2-52.5%		
		589 Hz	135-136	52.9-53.3%		
		590 Hz	137-138	53.7-54.1%		
		591 Hz	139-140	54.5-54.9%		
		592 Hz	141-142	55.3-55.7%		
		593 Hz	143-144	56.1-56.5%		
		594 Hz	145-146	56.9-57.3%		
		595 Hz	147-148	57.6-58.0%		
		596 Hz	149-150	58.4-58.8%		
		597 Hz	151-152	59.2-59.6%		
		598 Hz	153-154	60.0-60.4%		
		599 Hz	155-156	60.8-61.2%		
		600 Hz	157-158	61.6-62.0%		
		601 Hz	159-160	62.4-62.7%		
		602 Hz	161-162	63.1-63.5%		
		603 Hz	163-164	63.9-64.3%		
		604 Hz	165-166	64.7-65.1%		
		605 Hz	167-168	65.5-65.9%		
		606 Hz	169-170	66.3-66.7%		
		607 Hz	171-172	67.1-67.5%		
		608 Hz	173-174	67.8-68.2%		
609 Hz	175-176	68.6-69.0%				
610 Hz	177-178	69.4-69.8%				
611 Hz	179-180	70.2-70.6%				

7	Special /Control (continued)	612 Hz	181-182	71.0-71.4%		
		613 Hz	183-184	71.8-72.2%		
		614 Hz	185-186	72.5-72.9%		
		615 Hz	187-188	73.3-73.7%		
		616 Hz	189-190	74.1-74.5%		
		617 Hz	191-192	74.9-75.3%		
		618 Hz	193-194	75.6-76.1%		
		1200 Hz	195-197	76.5-77.3%		
		2400 Hz	198-200	77.6-78.4%		
		Fan mode = Auto	201-204	78.8-80.0%		
		Fan mode = High	205-209	80.4-82.0%		
		Percentage flash mode (hold for >0.5 sec.)	210-214	82.5-84.0%		
		Normal flash mode (hold for >0.5 sec.)	215-219	84.5-85.0%		
		Dimmer flash mode on*	220-224	86.0-87.5%		
		Dimmer flash mode off*	225-229	88.0-90.0%		
		FX color priority = Beam*	230-233	90.5-91.4%		
		FX color priority = Mixed*	234-236	91.8-92.5%		
		FX color priority = Plate*	237-239	92.9-93.7%		
Aggressive flash mode (hold for >0.5 sec.)	240-244	94.1-95.7%				
No function	245-247	96.1-96.9%				
Reset (hold value for >5 sec.)	248-255	97.3-100%				
8	Plate Intensity	Intensity 0-100%	0-255	0-100%	0	Fade
9	Plate Flash Duration	7-650 ms	0-255	0-100%	255	Fade
10	Plate Flash Rate	0.289-16.67 Hz	0-255	0-100%	255	Fade
11	Plate Shutter	No function	0	0%	0	Snap
		Plate Shutter effects and FX patterns offset:				
		10°	1	0.4%		
		20°	2	0.8%		
		30°	3	1.2%		
		40°	4	1.6%		
		50°	5	2.0%		
		60°	6	2.4%		
		70°	7	2.8%		
		80°	8	3.1%		
		90°	9	3.5%		
		100°	10	3.9%		
		110°	11	4.3%		
		120°	12	4.7%		
		130°	13	5.1%		
		140°	14	5.5%		
		150°	15	5.9%		
		160°	16	6.3%		
		170°	17	6.7%		
		180°	18	7.1%		
		190°	19	7.5%		
		200°	20	7.8%		
210°	21	8.2%				
220°	22	8.6%				

11	Plate Shutter (continued)	240°	24	9.4%		
		250°	25	9.8%		
		260°	26	10.2%		
		270°	27	10.6%		
		280°	28	11.0%		
		290°	29	11.4%		
		300°	30	11.8%		
		310°	31	12.2%		
		320°	32	12.6%		
		330°	33	12.9%		
		340°	34	13.3%		
		350°	35	13.7%		
		360°	36	14.1%		
		Ramp up (fade on, snap off)	37-40	14.5-15.5%		
		Ramp up, random	41-44	16.0-17.0%		
		Ramp down	45-48	17.5-18.5%		
		Ramp down, random	49-52	19.0-20.0%		
		Ramp up / down	53-56	20.5-21.5%		
		Ramp up / down, random	57-60	22.0-23.0%		
		Random white beam	61-64	23.5-24.5%		
		Random single pixel of white beam	65-68	25.0-26.0%		
		Lightning	69-72	26.5-27.5%		
		Spikes (flash over low light)	73-76	28.0-29.0%		
		No function	77-179	29.5-70.0%		
		Double flash	180-191	70.6-74.9%		
		Double flash, random	192-203	75.3-79.6%		
Triple flash	204-215	80.0-84.3%				
Triple flash, random	216-227	84.7-89.0%				
Quad flash	228-239	89.4-93.7%				
Quad flash, random	240-251	94.1-98.4%				
No effect	252-255	98.5-100%				
12	Plates Red	Both plates red intensity 0-100%	0-255	0-100%	255	Fade
13	Plates Green	Both plates green intensity 0-100%	0-255	0-100%	255	Fade
14	Plates Blue	Both plates blue intensity 0-100%	0-255	0-100%	255	Fade
15	Plate Pixel 1	Red intensity 0-100%	0-100%	0-255	0	Fade
16		Green intensity 0-100%	0-100%	0-255	0	Fade
17	Plate Pixel 2	Blue intensity 0-100%	0-100%	0-255	0	Fade
18		Red intensity 0-100%	0-100%	0-255	0	Fade
19		Green intensity 0-100%	0-100%	0-255	0	Fade
20	Plate Pixel 3	Blue intensity 0-100%	0-100%	0-255	0	Fade
21		Red intensity 0-100%	0-100%	0-255	0	Fade
22		Green intensity 0-100%	0-100%	0-255	0	Fade
23	Plate Pixel 4	Blue intensity 0-100%	0-100%	0-255	0	Fade
24		Red intensity 0-100%	0-100%	0-255	0	Fade
25		Green intensity 0-100%	0-100%	0-255	0	Fade
26	Plate Pixel 5	Blue intensity 0-100%	0-100%	0-255	0	Fade
27		Red intensity 0-100%	0-100%	0-255	0	Fade
28		Green intensity 0-100%	0-100%	0-255	0	Fade
29	Plate Pixel 6	Blue intensity 0-100%	0-100%	0-255	0	Fade
30		Red intensity 0-100%	0-100%	0-255	0	Fade
31		Green intensity 0-100%	0-100%	0-255	0	Fade
32		Blue intensity 0-100%	0-100%	0-255	0	Fade

33	Plate Pixel 7	Red intensity 0-100%	0-100%	0-255	0	Fade
34		Green intensity 0-100%	0-100%	0-255	0	Fade
35		Blue intensity 0-100%	0-100%	0-255	0	Fade
36	Plate Pixel 8	Red intensity 0-100%	0-100%	0-255	0	Fade
37		Green intensity 0-100%	0-100%	0-255	0	Fade
38		Blue intensity 0-100%	0-100%	0-255	0	Fade
39	Plate Pixel 9	Red intensity 0-100%	0-100%	0-255	0	Fade
40		Green intensity 0-100%	0-100%	0-255	0	Fade
41		Blue intensity 0-100%	0-100%	0-255	0	Fade
42	Plate Pixel 10	Red intensity 0-100%	0-100%	0-255	0	Fade
43		Green intensity 0-100%	0-100%	0-255	0	Fade
44		Blue intensity 0-100%	0-100%	0-255	0	Fade
45	Plate Pixel 11	Red intensity 0-100%	0-100%	0-255	0	Fade
46		Green intensity 0-100%	0-100%	0-255	0	Fade
47		Blue intensity 0-100%	0-100%	0-255	0	Fade
48	Plate Pixel 12	Red intensity 0-100%	0-100%	0-255	0	Fade
49		Green intensity 0-100%	0-100%	0-255	0	Fade
50		Blue intensity 0-100%	0-100%	0-255	0	Fade
51	Beam Pixels	Pixel 1 intensity 0-100%	0-100%	0-255	0	Fade
52		Pixel 2 intensity 0-100%	0-100%	0-255	0	Fade
53		Pixel 3 intensity 0-100%	0-100%	0-255	0	Fade
54		Pixel 4 intensity 0-100%	0-100%	0-255	0	Fade
55		Pixel 5 intensity 0-100%	0-100%	0-255	0	Fade
56		Pixel 6 intensity 0-100%	0-100%	0-255	0	Fade
57		Pixel 7 intensity 0-100%	0-100%	0-255	0	Fade
58		Pixel 8 intensity 0-100%	0-100%	0-255	0	Fade
59		Pixel 9 intensity 0-100%	0-100%	0-255	0	Fade
60		Pixel 10 intensity 0-100%	0-100%	0-255	0	Fade
61		Pixel 11 intensity 0-100%	0-100%	0-255	0	Fade
62		Pixel 12 intensity 0-100%	0-100%	0-255	0	Fade

DMX Mode 5 (1Pix Pro), 17 DMX Channels

Tilt, Beam shutter, special/control, Plates shutter, Plates grouped RGB, Plates background grouped RGB

Channel	Command	DMX range	Percent	Default DMX	Fade	
1	Coarse Tilt (MSB)	0-185°	0-255	0-100%	127	Fade
2	Fine Tilt (LSB)	Coarse tilt + 0-1.2°	0-255	0-100%	127	Fade
3	Beam Intensity	Intensity 0-100%	0-255	0-100%	0	Fade
4	Beam Duration	Flash duration 7-650 ms	0-255	0-100%	255	Fade
5	Beam Rate	Flash rate 0.289-16.67 Hz	0-255	0-100%	255	Fade
6	Beam Shutter	No effect	0-36	0-14.0%	0	Snap
		Ramp up (= fade on, snap off)	37-40	14.5-15.5%		
		Ramp up random	41-44	16.0-17.0%		
		Ramp down	45-48	17.5-18.5%		
		Ramp down random	49-52	19.0-20.0%		
		Ramp up down	53-56	20.5-21.5%		
		Ramp up down random	57-60	22.0-23.0%		
		Random white beam	61-64	23.5-24.5%		
		Random single pixel of white beam	65-68	25.0-26.0%		
		Lightning	69-72	26.5-27.5%		
		Spikes (flash over low light)	73-76	28.0-29.0%		
		White beam, left to right	77-80	30.0-31.5%		
		White beam, left to right, random	81-84	32.0-33.0%		
		White beam, right to left	85-88	33.5-34.5%		
		White beam, right to left, random	89-92	35.0-36.0%		
		White beam, left to right, bounce	93-96	36.5-37.5%		
		White beam, left to right, bounce, random	97-100	38.0-39.0%		
		White beam, right to left, bounce	101-104	39.5-40.5%		
		White beam, right to left, bounce, random	105-108	41.0-42.5%		
		Zig, 6 steps, outer to center pixels	109-112	43.0-43.5%		
		Zig, 6 steps, outer to center pixels random	113-116	44.0-45.5%		
		Zag, 6 steps, center to outer pixels	117-120	46.0-47.0%		
		Zag, 6 steps, center to outer pixels, random	121-124	47.5-48.5%		
		Zigzag, 10 steps	125-128	49.0-50.0%		
		Zigzag, 10 steps, random	129-132	50.5-52.0%		
		No function	133-179	52.5-70.0%		
		Double flash	180-183	70.6-71.8%		
		Double flash, random	184-187	72.2-73.3%		
		Double flash, b-c (beam-color)	188-191	73.7-74.9%		
		Double flash, b-c, random	192-195	75.3-76.5%		
		Double flash, c-b (color-beam)	196-199	76.9-78.0%		
		Double flash, c-b, random	200-203	78.4-79.6%		
Triple flash	204-207	80.0-81.2%				
Triple flash, random	208-211	81.6-82.7%				
Triple flash, beam-color-beam	212-215	83.1-84.3%				
Triple flash, b-c-b, random	216-219	84.7-85.9%				
Triple flash, c-b-c	220-223	86.3-87.5%				
Triple flash, c-b-c, random	224-227	87.8-89.0%				

6	Beam Shutter (continued)	Quad flash	228-231	89.4-90.6%		
		Quad flash, random	232-235	91.0-92.2%		
		Quad flash, b-c-b-c	236-239	92.5-93.7%		
		Quad flash, b-c-b-c, random	240-243	94.1-95.3%		
		Quad flash, c-b-c-b	244-247	95.7-96.9%		
		Quad flash, c-b-c-b, random	248-251	97.3-98.4%		
		No function	252-255	98.5-100%		
7	Special / Control	No function	0	0%	0	Snap
		Beam Shutter effects and FX patterns offset:				
		10°	1	0.4%		
		20°	2	0.8%		
		30°	3	1.2%		
		40°	4	1.6%		
		50°	5	2.0%		
		60°	6	2.4%		
		70°	7	2.8%		
		80°	8	3.1%		
		90°	9	3.5%		
		100°	10	3.9%		
		110°	11	4.3%		
		120°	12	4.7%		
		130°	13	5.1%		
		140°	14	5.5%		
		150°	15	5.9%		
		160°	16	6.3%		
		170°	17	6.7%		
		180°	18	7.1%		
		190°	19	7.5%		
		200°	20	7.8%		
		210°	21	8.2%		
		220°	22	8.6%		
		230°	23	9.0%		
		240°	24	9.4%		
		250°	25	9.8%		
		260°	26	10.2%		
		270°	27	10.6%		
		280°	28	11.0%		
		290°	29	11.4%		
		300°	30	11.8%		
		310°	31	12.2%		
		320°	32	12.6%		
		330°	33	12.9%		
		340°	34	13.3%		
		350°	35	13.7%		
360°	36	14.1%				
No function	37-39	14.5-15.3%				

7	Special / Control (continued)	Position feedback on*	40-44	15.7-17.3%		
		Position feedback off*	45-49	17.7-19.2%		
		Barndoor on*	50-54	19.6-21.2%		
		Barndoor off*	55-59	21.6-23.1%		
		No function	60-61	23.5-23.9%		
		Tilt power on*	62-63	24.3-24.7%		
		Tilt power off*	64-65	25.1-25.5%		
		Tilt reset on*	66-67	25.9-26.3%		
		Tilt reset off*	68-69	26.7-27.1%		
		Normal tilt control*	70-74	27.5-29.0%		
		Inverse tilt control*	75-79	29.4-31.0%		
		Normal pixel numbering, plates 1+2	80-84	31.4-32.9%		
		Inverse pixel numbering, plates 1+2	85-89	33.3-34.9%		
		Normal pixel numbering, 2nd plate	90-94	35.3-36.9%		
		Inverse pixel numbering, 2nd plate	95-99	37.3-38.8%		
		Linear dimming curve	100-101	39.2-39.6%		
		Soft dimming curve	102-103	40.0-40.4%		
		Extra-soft dimming curve	104-105	40.8-41.2%		
		No function	106-120	41.6-47.1%		
		PWM frequency (hold value for >3 seconds):				
		582 Hz	121-122	47.5-47.8%		
		583 Hz	123-124	48.2-48.6%		
		584 Hz	125-126	49.0-49.4%		
		585 Hz	127-128	49.8-50.2%		
		586 Hz	129-130	50.6-51.0%		
		587 Hz	131-132	51.4-51.8%		
		588 Hz	133-134	52.2-52.5%		
		589 Hz	135-136	52.9-53.3%		
		590 Hz	137-138	53.7-54.1%		
		591 Hz	139-140	54.5-54.9%		
		592 Hz	141-142	55.3-55.7%		
		593 Hz	143-144	56.1-56.5%		
		594 Hz	145-146	56.9-57.3%		
		595 Hz	147-148	57.6-58.0%		
		596 Hz	149-150	58.4-58.8%		
		597 Hz	151-152	59.2-59.6%		
		598 Hz	153-154	60.0-60.4%		
		599 Hz	155-156	60.8-61.2%		
		600 Hz	157-158	61.6-62.0%		
		601 Hz	159-160	62.4-62.7%		
		602 Hz	161-162	63.1-63.5%		
		603 Hz	163-164	63.9-64.3%		
		604 Hz	165-166	64.7-65.1%		
		605 Hz	167-168	65.5-65.9%		
		606 Hz	169-170	66.3-66.7%		
		607 Hz	171-172	67.1-67.5%		
		608 Hz	173-174	67.8-68.2%		
609 Hz	175-176	68.6-69.0%				
610 Hz	177-178	69.4-69.8%				
611 Hz	179-180	70.2-70.6%				

7	Special /Control (continued)	612 Hz	181-182	71.0-71.4%		
		613 Hz	183-184	71.8-72.2%		
		614 Hz	185-186	72.5-72.9%		
		615 Hz	187-188	73.3-73.7%		
		616 Hz	189-190	74.1-74.5%		
		617 Hz	191-192	74.9-75.3%		
		618 Hz	193-194	75.6-76.1%		
		1200 Hz	195-197	76.5-77.3%		
		2400 Hz	198-200	77.6-78.4%		
		Fan mode = Auto	201-204	78.8-80.0%		
		Fan mode = High	205-209	80.4-82.0%		
		Percentage flash mode (hold for >0.5 sec.)	210-214	82.5-84.0%		
		Normal flash mode (hold for >0.5 sec.)	215-219	84.5-85.0%		
		Dimmer flash mode on*	220-224	86.0-87.5%		
		Dimmer flash mode off*	225-229	88.0-90.0%		
		FX color priority = Beam*	230-233	90.5-91.4%		
		FX color priority = Mixed*	234-236	91.8-92.5%		
		FX color priority = Plate*	237-239	92.9-93.7%		
Aggressive flash mode (hold for >0.5 sec.)	240-244	94.1-95.7%				
No function	245-247	96.1-96.9%				
Reset (hold value for >5 sec.)	248-255	97.3-100%				
8	Plate Intensity	Intensity 0-100%	0-255	0-100%	0	Fade
9	Plate Flash Duration	7-650 ms	0-255	0-100%	255	Fade
10	Plate Flash Rate	0.289-16.67 Hz	0-255	0-100%	255	Fade
11	Plate Shutter	No function	0	0%	0	Snap
		Plate Shutter effects and FX patterns offset:				
		10°	1	0.4%		
		20°	2	0.8%		
		30°	3	1.2%		
		40°	4	1.6%		
		50°	5	2.0%		
		60°	6	2.4%		
		70°	7	2.8%		
		80°	8	3.1%		
		90°	9	3.5%		
		100°	10	3.9%		
		110°	11	4.3%		
		120°	12	4.7%		
		130°	13	5.1%		
		140°	14	5.5%		
		150°	15	5.9%		
		160°	16	6.3%		
		170°	17	6.7%		
		180°	18	7.1%		
		190°	19	7.5%		
		200°	20	7.8%		
210°	21	8.2%				
220°	22	8.6%				

11	Plate Shutter (continued)	240°	24	9.4%		
		250°	25	9.8%		
		260°	26	10.2%		
		270°	27	10.6%		
		280°	28	11.0%		
		290°	29	11.4%		
		300°	30	11.8%		
		310°	31	12.2%		
		320°	32	12.6%		
		330°	33	12.9%		
		340°	34	13.3%		
		350°	35	13.7%		
		360°	36	14.1%		
		Ramp up (fade on, snap off)	37-40	14.5-15.5%		
		Ramp up, random	41-44	16.0-17.0%		
		Ramp down	45-48	17.5-18.5%		
		Ramp down, random	49-52	19.0-20.0%		
		Ramp up / down	53-56	20.5-21.5%		
		Ramp up / down, random	57-60	22.0-23.0%		
		Random white beam	61-64	23.5-24.5%		
		Random single pixel of white beam	65-68	25.0-26.0%		
		Lightning	69-72	26.5-27.5%		
		Spikes (flash over low light)	73-76	28.0-29.0%		
		No function	77-179	29.5-70.0%		
		Double flash	180-191	70.6-74.9%		
Double flash, random	192-203	75.3-79.6%				
Triple flash	204-215	80.0-84.3%				
Triple flash, random	216-227	84.7-89.0%				
Quad flash	228-239	89.4-93.7%				
Quad flash, random	240-251	94.1-98.4%				
No effect	252-255	98.5-100%				
12	Plates Red	Both plates red intensity 0-100%	0-255	0-100%	255	Fade
13	Plates Green	Both plates green intensity 0-100%	0-255	0-100%	255	Fade
14	Plates Blue	Both plates blue intensity 0-100%	0-255	0-100%	255	Fade
15	Plates Flash Background Red	Intensity 0-100%	0-255	0-100%	0	Fade
16	Plates Flash Background Green	Intensity 0-100%	0-255	0-100%	0	Fade
17	Plates Flash Background Blue	Intensity 0-100%	0-255	0-100%	0	Fade

DMX Mode 6 (Easy), 11 DMX Channels

Tilt, Beam shutter, special/control, Plates grouped RGBW

Channel	Command	DMX range	Percent	Default DMX	Fade	
1	Coarse Tilt (MSB)	0-185°	0-255	0-100%	127	Fade
2	Fine Tilt (LSB)	Coarse tilt + 0-1.2°	0-255	0-100%	127	Fade
3	Beam Intensity	Intensity 0-100%	0-255	0-100%	0	Fade
4	Beam Duration	Flash duration 7-650 ms	0-255	0-100%	255	Fade
5	Beam Rate	Flash rate 0.289-16.67 Hz	0-255	0-100%	255	Fade
6	Beam Shutter	No effect	0-36	0-14.0%	0	Snap
		Ramp up (= fade on, snap off)	37-40	14.5-15.5%		
		Ramp up random	41-44	16.0-17.0%		
		Ramp down	45-48	17.5-18.5%		
		Ramp down random	49-52	19.0-20.0%		
		Ramp up down	53-56	20.5-21.5%		
		Ramp up down random	57-60	22.0-23.0%		
		Random white beam	61-64	23.5-24.5%		
		Random single pixel of white beam	65-68	25.0-26.0%		
		Lightning	69-72	26.5-27.5%		
		Spikes (flash over low light)	73-76	28.0-29.0%		
		White beam, left to right	77-80	30.0-31.5%		
		White beam, left to right, random	81-84	32.0-33.0%		
		White beam, right to left	85-88	33.5-34.5%		
		White beam, right to left, random	89-92	35.0-36.0%		
		White beam, left to right, bounce	93-96	36.5-37.5%		
		White beam, left to right, bounce, random	97-100	38.0-39.0%		
		White beam, right to left, bounce	101-104	39.5-40.5%		
		White beam, right to left, bounce, random	105-108	41.0-42.5%		
		Zig, 6 steps, outer to center pixels	109-112	43.0-43.5%		
		Zig, 6 steps, outer to center pixels random	113-116	44.0-45.5%		
		Zag, 6 steps, center to outer pixels	117-120	46.0-47.0%		
		Zag, 6 steps, center to outer pixels, random	121-124	47.5-48.5%		
		Zigzag, 10 steps	125-128	49.0-50.0%		
		Zigzag, 10 steps, random	129-132	50.5-52.0%		
		No function	133-179	52.5-70.0%		
		Double flash	180-183	70.6-71.8%		
		Double flash, random	184-187	72.2-73.3%		
		Double flash, b-c (beam-color)	188-191	73.7-74.9%		
		Double flash, b-c, random	192-195	75.3-76.5%		
		Double flash, c-b (color-beam)	196-199	76.9-78.0%		
		Double flash, c-b, random	200-203	78.4-79.6%		
Triple flash	204-207	80.0-81.2%				
Triple flash, random	208-211	81.6-82.7%				
Triple flash, beam-color-beam	212-215	83.1-84.3%				
Triple flash, b-c-b, random	216-219	84.7-85.9%				
Triple flash, c-b-c	220-223	86.3-87.5%				
Triple flash, c-b-c, random	224-227	87.8-89.0%				

6	Beam Shutter (continued)	Quad flash	228-231	89.4-90.6%		
		Quad flash, random	232-235	91.0-92.2%		
		Quad flash, b-c-b-c	236-239	92.5-93.7%		
		Quad flash, b-c-b-c, random	240-243	94.1-95.3%		
		Quad flash, c-b-c-b	244-247	95.7-96.9%		
		Quad flash, c-b-c-b, random	248-251	97.3-98.4%		
		No function	252-255	98.5-100%		
7	Special / Control	No function	0	0%	0	Snap
		Beam Shutter effects and FX patterns offset:				
		10°	1	0.4%		
		20°	2	0.8%		
		30°	3	1.2%		
		40°	4	1.6%		
		50°	5	2.0%		
		60°	6	2.4%		
		70°	7	2.8%		
		80°	8	3.1%		
		90°	9	3.5%		
		100°	10	3.9%		
		110°	11	4.3%		
		120°	12	4.7%		
		130°	13	5.1%		
		140°	14	5.5%		
		150°	15	5.9%		
		160°	16	6.3%		
		170°	17	6.7%		
		180°	18	7.1%		
		190°	19	7.5%		
		200°	20	7.8%		
		210°	21	8.2%		
		220°	22	8.6%		
		230°	23	9.0%		
		240°	24	9.4%		
		250°	25	9.8%		
		260°	26	10.2%		
		270°	27	10.6%		
		280°	28	11.0%		
		290°	29	11.4%		
		300°	30	11.8%		
		310°	31	12.2%		
		320°	32	12.6%		
		330°	33	12.9%		
		340°	34	13.3%		
		350°	35	13.7%		
360°	36	14.1%				
No function	37-39	14.5-15.3%				

7	Special / Control (continued)	Position feedback on*	40-44	15.7-17.3%		
		Position feedback off*	45-49	17.7-19.2%		
		Barndoor on*	50-54	19.6-21.2%		
		Barndoor off*	55-59	21.6-23.1%		
		No function	60-61	23.5-23.9%		
		Tilt power on*	62-63	24.3-24.7%		
		Tilt power off*	64-65	25.1-25.5%		
		Tilt reset on*	66-67	25.9-26.3%		
		Tilt reset off*	68-69	26.7-27.1%		
		Normal tilt control*	70-74	27.5-29.0%		
		Inverse tilt control*	75-79	29.4-31.0%		
		Normal pixel numbering, plates 1+2	80-84	31.4-32.9%		
		Inverse pixel numbering, plates 1+2	85-89	33.3-34.9%		
		Normal pixel numbering, 2nd plate	90-94	35.3-36.9%		
		Inverse pixel numbering, 2nd plate	95-99	37.3-38.8%		
		Linear dimming curve	100-101	39.2-39.6%		
		Soft dimming curve	102-103	40.0-40.4%		
		Extra-soft dimming curve	104-105	40.8-41.2%		
		No function	106-120	41.6-47.1%		
		PWM frequency (hold value for >3 seconds):				
		582 Hz	121-122	47.5-47.8%		
		583 Hz	123-124	48.2-48.6%		
		584 Hz	125-126	49.0-49.4%		
		585 Hz	127-128	49.8-50.2%		
		586 Hz	129-130	50.6-51.0%		
		587 Hz	131-132	51.4-51.8%		
		588 Hz	133-134	52.2-52.5%		
		589 Hz	135-136	52.9-53.3%		
		590 Hz	137-138	53.7-54.1%		
		591 Hz	139-140	54.5-54.9%		
		592 Hz	141-142	55.3-55.7%		
		593 Hz	143-144	56.1-56.5%		
		594 Hz	145-146	56.9-57.3%		
		595 Hz	147-148	57.6-58.0%		
		596 Hz	149-150	58.4-58.8%		
		597 Hz	151-152	59.2-59.6%		
		598 Hz	153-154	60.0-60.4%		
		599 Hz	155-156	60.8-61.2%		
		600 Hz	157-158	61.6-62.0%		
		601 Hz	159-160	62.4-62.7%		
		602 Hz	161-162	63.1-63.5%		
		603 Hz	163-164	63.9-64.3%		
		604 Hz	165-166	64.7-65.1%		
		605 Hz	167-168	65.5-65.9%		
		606 Hz	169-170	66.3-66.7%		
		607 Hz	171-172	67.1-67.5%		
		608 Hz	173-174	67.8-68.2%		
609 Hz	175-176	68.6-69.0%				
610 Hz	177-178	69.4-69.8%				
611 Hz	179-180	70.2-70.6%				









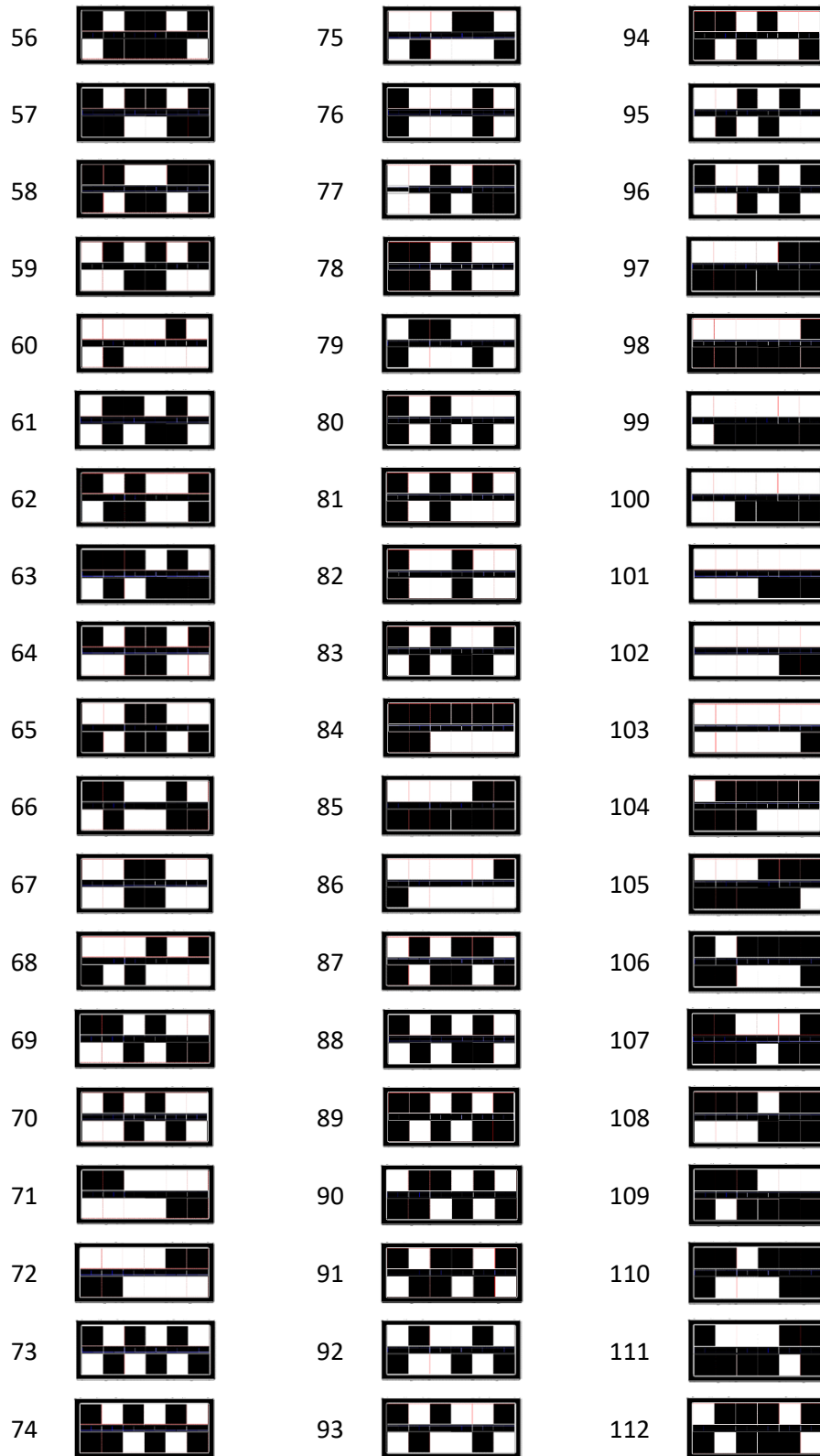

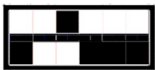
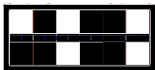
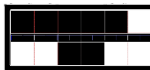

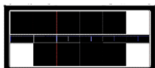
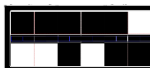
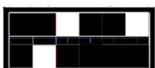

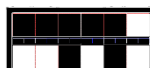
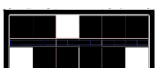

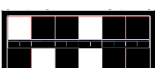



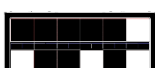

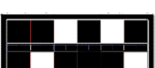
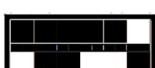
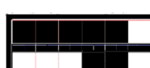

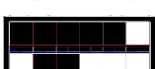
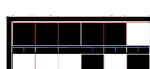
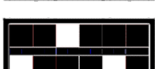
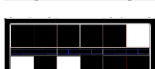







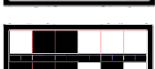





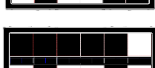



7	Special /Control (continued)	612 Hz	181-182	71.0-71.4%		
		613 Hz	183-184	71.8-72.2%		
		614 Hz	185-186	72.5-72.9%		
		615 Hz	187-188	73.3-73.7%		
		616 Hz	189-190	74.1-74.5%		
		617 Hz	191-192	74.9-75.3%		
		618 Hz	193-194	75.6-76.1%		
		1200 Hz	195-197	76.5-77.3%		
		2400 Hz	198-200	77.6-78.4%		
		Fan mode = Auto	201-204	78.8-80.0%		
		Fan mode = High	205-209	80.4-82.0%		
		Percentage flash mode (hold for >0.5 sec.)	210-214	82.5-84.0%		
		Normal flash mode (hold for >0.5 sec.)	215-219	84.5-85.0%		
		Dimmer flash mode on*	220-224	86.0-87.5%		
		Dimmer flash mode off*	225-229	88.0-90.0%		
		FX color priority = Beam*	230-233	90.5-91.4%		
		FX color priority = Mixed*	234-236	91.8-92.5%		
FX color priority = Plate*	237-239	92.9-93.7%				
Aggressive flash mode (hold for >0.5 sec.)	240-244	94.1-95.7%				
No function	245-247	96.1-96.9%				
Reset (hold value for >5 sec.)	248-255	97.3-100%				
8	Plates Red	Plates red intensity 0-100%	0-255	0-100%	255	Fade
9	Plates Green	Plates green intensity 0-100%	0-255	0-100%	255	Fade
10	Plates Blue	Plates blue intensity 0-100%	0-255	0-100%	255	Fade
11	Plates White	Plates white intensity 0-100%	0-255	0-100%	255	Fade

9. Plate FX patterns

You can display the following dynamic patterns on the Plates in DMX modes 2 and 3 by sending the indicated DMX values on channel 17:



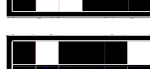
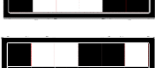
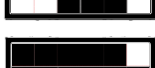

113		132		151	
114		133		152	
115		134		153	
116		135		154	
117		136		155	
118		137		156	
119		138		157	
120		139		158	
121		140		159	
122		141		160	
123		142		161	
124		143		162	
125		144		163	
126		145		164	
127		146		165	
128		147		166	
129		148		167	
130		149		168	
131		150		169	

170		191		210	
171		192		211	
172		193		212	
173		194		213	
174		195		214	
175		196		215	
176		197		216	
177		198		217	
178-180		199		218	
181		200		219	
182		201		220	
183		202		221	
184		203		222	
185		204		223	
186		205		224	
187		206		225	
188		207		226	
189		208		227	
190		209		228	

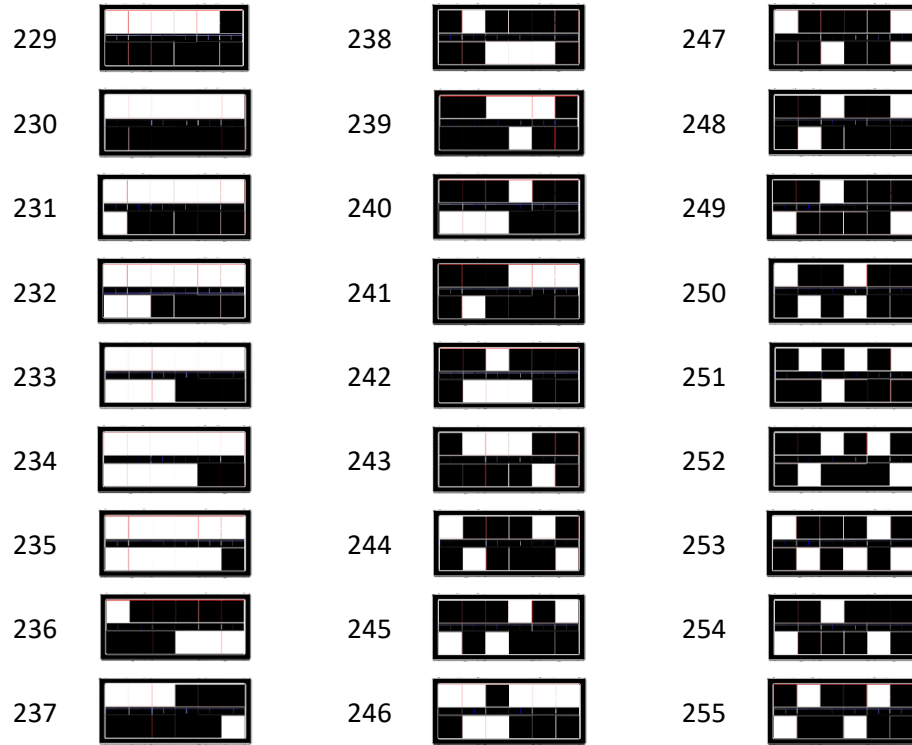

10. Beam FX patterns

You can display the following dynamic patterns on the Beam pixels in DMX modes 2 and 3 by sending the indicated DMX values on channel 19:

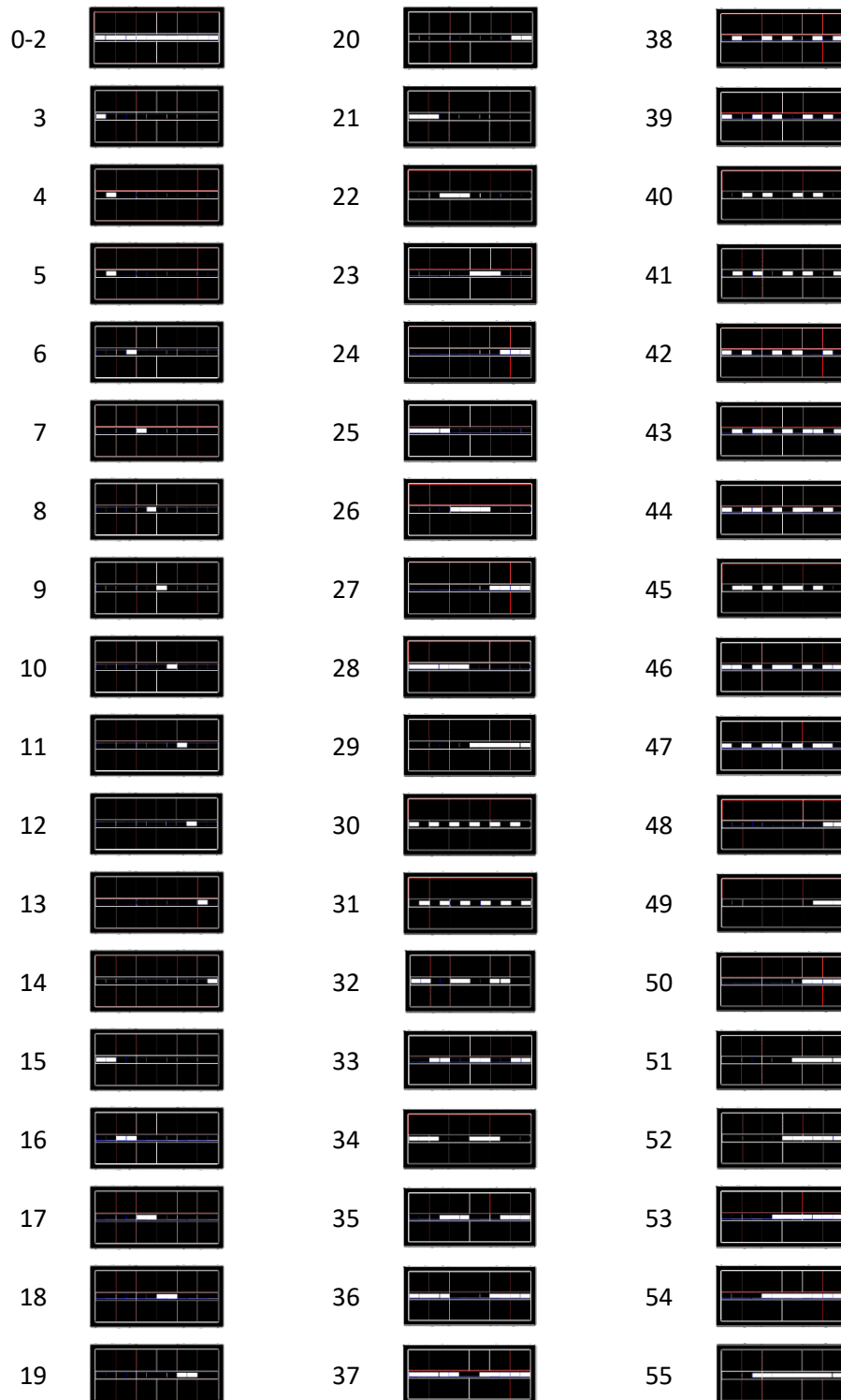

56		76		96	
57		77		97	
58		78		98	
59		79		99	
60		80		100	
61		81		101	
62		82		102	
63		83		103	
64		84		104	
65		85		105	
66		86		106	
67		87		107	
68		88		108	
69		89		109	
70		90		110	
71		91		111	
72		92		112	
73		93		113	
74		94		114	
75		95		115	

116		130		157	
117		131		158-160	
118		132		161	
119		133		162-164	
120		134		165	
121		135-145		166-255	
122		146			
123		147-149			
124		150			
125		151			
126		152			
127		153-154			
128		155			
129		156			

11. Cleaning and maintenance



WARNING! Any service operation that requires removal of a cover must be performed by a professional service technician with the necessary tools, skills and personal protective equipment to maintain high-powered lighting equipment safely and efficiently.

Suggested maintenance intervals

The cleaning schedule depends on the operating environment. The intervals below are suggestions from our experience with typical installations. Adjust as necessary.

Maintenance task	Interval	How
Front glass	Weekly	Soft cloth and glass cleaning fluid
Fans and air channel	Monthly	Vacuum cleaner and soft brush, etc.
Moveable parts	Yearly	Suitable lubricant

Cleaning

JDC1 components require occasional cleaning to prevent the buildup of dust, dirt, and smoke fluid residue. Pay special attention to the air vents and glass plate. Failure to keep the fixture clean will significantly reduce light output and may cause damage. Regular cleaning will ensure maximum performance and reliable operation.

You can clean the front glass with household or automotive glass cleaning products. Use a vacuum cleaner and soft brush to clean air vents.

GLP Service and Support

Contact information for the nearest GLP Service and Support is available online at www.glp.de/en/service, by email at info@glp.de, or by telephone at the following numbers:

- GLP Germany: +49 (7248) 927 19-55
- GLP N. America: +1 818 767-8899
- GLP UK: +44 1392 690140
- GLP Asia: +852 (3151) 7730
- GLP Nordic: +46 737 57 11 40

12. Technical Specifications

Plate LEDs

LED type: OSRAM LRTB GRTG
LED count: 1320
LED colors: RGB
LED segments: 12 (2 x 6)

Beam LEDs

LED type: CREE XP L LED
LED count: 216
LED color: Cool white
LED segments: 12

Movement

Resolution: 8 - 16 bit
Position feedback: Yes
Tilt: 185 °

Connectors

Signal connection: XLR 5-pin input and output
Power input: Neutrik powerCON TRUE1

Operating conditions

Mains voltage: 100-240 VAC / 50-60 Hz
Power (@ 230V): 1200 W
Fuse: 6.3 x 32 mm T15A
Maximum ambient temperature: 45° C / 113° F
Operating position: Any

Shipping options

Single fixture: Cardboard
Tour packs: 4-fixture and 8-fixture incl. flightcase

Dimensions and weight

Length: 154 mm (6.1 in)
Width: 390 mm (15.3 in)
Height (head horizontal): 284 mm (11.2 in)
Weight: 10.8 kg (24 lbs.)
Weight incl. bracket: 12 kg (26.5 lbs.)

13. Dimensions

