

MAVERICK STORM

4 PROFILE

User Manual



Model ID: MAVERICKSTORM4PROFILE

CHAUVET
PROFESSIONAL

Edition Notes

The Maverick Storm 4 Profile User Manual includes a description, safety precautions, installation, programming, operation, and maintenance instructions for the Maverick Storm 4 Profile as of the release date of this edition.

Trademarks

Chauvet, Chauvet Professional, the Chauvet logo, Maverick, and Maverick Storm are registered trademarks or trademarks of Chauvet & Sons, LLC (d/b/a Chauvet and Chauvet Lighting) in the United States and other countries. Other company and product names and logos referred to herein may be trademarks of their respective companies.

Copyright Notice

The works of authorship contained in this manual, including, but not limited to, all designs, text, and images are owned by Chauvet.

© Copyright 2023 Chauvet & Sons, LLC. All rights reserved.

Electronically published by Chauvet in the United States of America.

Manual Use

Chauvet authorizes its customers to download and print this manual for professional information purposes only. Chauvet expressly prohibits the usage, copy, storage, distribution, modification, or printing of this manual or its content for any other purpose without written consent from Chauvet.

Document Printing

For best results, print this document in color, on letter size paper (8.5 x 11 in), double-sided. If using A4 paper (210 x 297 mm), configure the printer to scale the content accordingly.

Intended Audience

Any person installing, operating, and/or maintaining this product should completely read through the guide that shipped with the product, as well as this manual, before installing, operating, or maintaining this product.

Disclaimer

Chauvet believes that the information contained in this manual is accurate in all respects. However, Chauvet assumes no responsibility and specifically disclaims any and all liability to any party for any loss, damage or disruption caused by any errors or omissions in this document, whether such errors or omissions result from negligence, accident or any other cause. Chauvet reserves the right to revise the content of this document without any obligation to notify any person or company of such revision, however, Chauvet has no obligation to make, and does not commit to make, any such revisions.

Document Revision

Go to www.chauvetprofessional.com for the latest version.

Revision	Date	Description
7	11/2023	Added note for transporting fixtures in pre-rigged truss and transporting racks.

TABLE OF CONTENTS

1. Before You Begin	1
What Is Included	1
Claims	1
Text Conventions	1
Symbols	1
Safety Notes.....	2
FCC Statement of Compliance	3
RF Exposure Warning for North America and Australia.....	3
Expected LED Lifespan.....	3
2. Introduction	4
Description	4
Features.....	4
Product Overview.....	4
Product Dimensions.....	5
3. Setup	6
AC Power	6
AC Plug.....	6
Fuse Replacement.....	6
USB Software Update	6
Signal Connections	7
Control Personalities	7
DMX Linking.....	7
Remote Device Management.....	7
Art-Net™ Connection	7
sACN Connection.....	7
Mounting	8
Orientation.....	8
Rigging	8
Procedure.....	8
4. Operation	9
Control Panel Description	9
Battery-Powered Display.....	9
Home Screen	9
Control Panel Lock.....	9
Passcode	9
Technician Mode.....	9
Menu Map	10
Control Configuration	15
Control Mode.....	15
Control Personalities	15
Starting Address.....	15
Network Setup.....	15
IP Mode.....	15
Universe.....	15
Manual IP Address.....	15
Subnet Mask.....	15
Control Channel Assignments and Values.....	16
Configuration Settings.....	20
Pan Reverse	20
Tilt Reverse	20

Screen Reverse	20
Pan Angle.....	20
Tilt Angle	20
Black out on Movement.....	20
Swap Pan and Tilt.....	20
WDMX Reset	20
Display Backlight Timer.....	20
Loss of Data	21
Fan Mode	21
Dimmer Curve	21
Pulse Width Modulation	21
LED Power	21
Minimum Zoom Focus.....	21
Preset Selection	21
Preset Synchronization	22
USB Update	22
Reset Function	22
Factory Reset.....	22
Test Mode	22
Auto Test.....	22
Manual Test	22
System Information	23
Offset Mode.....	23
Web Server	23
Gobo Wheels	24
Gobo Dimensions.....	24
Gobo Replacement	25
5. Maintenance.....	26
Product Maintenance	26
Torque Measurements	26
Vacuum Test Measurements	26
Transporting on Truss or Racks.....	27
6. Technical Specifications	28
Contact Us	29
Warranty & Returns.....	29

Before You Begin

1. Before You Begin

What Is Included

- Maverick Storm 4 Profile
- Seetronic Powerkon IP65 power cable
- 2 Omega brackets with mounting hardware
- Quick Reference Guide

Claims

Carefully unpack the product immediately and check the container to make sure all the parts are in the package and are in good condition.



If the box or the contents (the product and included accessories) appear damaged from shipping, or show signs of mishandling, notify the carrier immediately, not Chauvet. Failure to report damage to the carrier immediately may invalidate the claim. In addition, keep the box and contents for inspection.

For other issues, such as missing components or parts, damage not related to shipping, or concealed damage, file a claim with Chauvet within 7 days of delivery.

Text Conventions

Convention	Meaning
1–512	A range of values
50/60	A set of values of which only one can be chosen
Settings	A menu option not to be modified
<ENTER>	A key to be pressed on the product's control panel

Symbols

Symbol	Meaning
	Critical installation, configuration, or operation information. Not following these instructions may make the product not work, cause damage to the product, or cause harm to the operator.
	Important installation or configuration information. The product may not function correctly if this information is not used.
	Useful information.



Any reference to data or power connections in this manual assumes the use of Seetronic IP-rated cables.



The term “DMX” used throughout this manual refers to the USITT DMX512-A digital data transmission protocol.

Safety Notes

Read all the following safety notes before working with this product. These notes contain important information about the installation, usage, and maintenance of this product.



This product contains no user-serviceable parts. Any reference to servicing in this User Manual will only apply to properly trained, certified technicians. Do not open the housing or attempt any repairs.



All applicable local codes and regulations apply to proper installation of this product.

- The luminaire is intended for professional use only.
- The luminaire should be positioned so that prolonged staring into the luminaire at a distance closer than 37.73 ft (11.5 m) is not expected.
- If the external flexible cable or cord of this luminaire is damaged, it shall be replaced by a special cord or cord exclusively available from the manufacturer or its service agent.
- The light source contained in this luminaire shall only be replaced by the manufacturer or its service agent or a similar qualified person.
- **CAUTION:**
 - This product's housing may be hot when operating. Mount this product in a location with adequate ventilation, at least 20 in (50 cm) from adjacent surfaces.
 - When transferring the product from extreme temperature environments, (e.g., cold truck to warm humid ballroom) condensation may form on the internal electronics of the product. To avoid causing a failure, allow the product to fully acclimate to the surrounding environment before connecting it to power.
 - Flashing light is known to trigger epileptic seizures. User must comply with local laws regarding notification of strobe use.
- **ALWAYS:**
 - Disconnect from power before cleaning the product or replacing the fuse.
 - When using an IP65-rated product in an outdoor environment, use IP65- (or higher) rated power and data cable.
 - Replace and secure IP-rated protective covers to all power, data, USB, or other ports when not in use.
 - Replace the fuse with the same type and rating.
 - Use a safety cable when mounting this product overhead.
 - Connect this product to a grounded and protected circuit.
- **DO NOT:**
 - Open this product. It contains no user-serviceable parts.
 - Look at the light source when the product is on.
 - Leave any flammable material within 20 cm of this product while operating or connected to power.
 - Connect this product to a dimmer or rheostat.
 - Operate this product if the housing, lenses, or cables appear damaged.
 - Submerge this product (adhere to standards for the published IP rating). Regular outdoor operation is fine.
 - Permanently install outdoors in locations with extreme environmental conditions. This includes, but is not limited to:
 - Exposure to a marine/saline environment (within 3 miles of a saltwater body of water).
 - Locations where normal temperatures exceed the temperature ranges in this manual.
 - Locations that are prone to flooding or being buried in snow.
 - Other areas where the product will be subject to extreme radiation or caustic substances.
- **ONLY** use the hanging/mounting bracket to carry this product.
- The maximum ambient temperature is 113 °F (45 °C). Do not operate this product at higher temperatures.
- The minimum startup temperature is -4°F (-20°C). Do not start the product at lower temperatures.
- The minimum ambient temperature is -22°F (-30°C). Do not operate the product at lower temperatures.
- To eliminate unnecessary wear and improve its lifespan, during periods of non-use completely disconnect the product from power via breaker or by unplugging it.
- In the event of a serious operating problem, stop using immediately.



If a Chauvet product requires service, contact Chauvet Technical Support.

Before You Begin

FCC Statement of Compliance

This device complies with Part 15 Part B of the FCC rules. Operation is subject to the following two conditions:

1. This device may not cause harmful interference, and
2. This device must accept any interference received, including interference that may cause undesired operation.

This equipment has been tested and found to comply with the limits for a Class B digital device, pursuant to Part 15 of the FCC Rules. These limits are designed to provide reasonable protection against harmful interference in a residential installation. This equipment generates uses and can radiate radio frequency energy and, if not installed and used in accordance with the instructions, may cause harmful interference to radio communications. However, there is no guarantee that interference will not occur in a particular installation. If this equipment does cause harmful interference to radio or television reception, which can be determined by turning the equipment off and on, the user is encouraged to try to correct the interference by one or more of the following measures:

- Reorient or relocate the receiving antenna.
- Increase the separation between the equipment and receiver.
- Connect the equipment into an outlet on a circuit different from that to which the receiver is connected.
- Consult the dealer or an experienced radio/TV technician for help.

Any changes or modifications not expressly approved by the party responsible for compliance could void the user's authority to operate the equipment.

RF Exposure Warning for North America and Australia

Warning! This equipment complies with FCC radiation exposure limits set forth for an uncontrolled environment. This equipment should be installed and operated with a minimum distance of 20 cm between the radiator and the user. This transmitter must not be co-located or operating in conjunction with any other antenna or transmitter.

Expected LED Lifespan

Over time, use and heat will gradually reduce LED brightness. Clustered LEDs produce more heat than single LEDs, contributing to shorter lifespans if always used at full intensity. The average LED lifespan is 40,000 to 50,000 hours. To extend LED lifespan, maintain proper ventilation around the product, and limit the overall intensity.

2. Introduction

Description

Maverick Storm 4 Profile brings indomitable long throw performance to even the largest venues. Its ambitious design launches over 60,000 lumens across incredible distances with commanding brightness. Built to outshine, this Maverick brings more to a show than its long throw. Master the art of domination with a sophisticated variable CMY+CTO system that delivers fantastic color rendering. Double down on crisp gobos to create complex looks with two rotating gobo wheels, two prisms, two frost filters, and an animation wheel to add even more texture. Sharp shutter framing, smooth iris and 8.5:1 zoom complete a Maverick that delivers key light and high-energy kinetic effects, in an advanced IP65 alloy body that carries SunShield tech inside to protect optical components from any solar ingress through its audacious 188mm front lens.

Features

- Fully featured, compact, and lightweight IP65 1250 W LED yoke profile fixture, including CMY + CTO color mixing, a four-blade framing shutter system with rotation, a color wheel, 8:1 zoom, two prisms (five-facet round and linear), two rotating gobo wheels, and integrated sun shield
- 16-bit dimming of master dimmer for smooth control of fades
- Variable CMY + CTO color mixing system to create a wide pallet of colors
- CRI and CTB filters on color wheel for added flexibility
- Two rotating, indexing, and interchangeable slot and lock gobo wheels
- An animation wheel for kinetic textured effects
- DMX, WDMX, sACN, and Art-Net for full flexibility of control options
- RDM control over DMX for fixture reporting
- 5.6° to 56.8° zoom range for variable beam sizes
- Iris, five-facet round and linear prisms, and two frosts (light and medium) for beam control
- TRUE1-compatible power input
- Integrated sun shield for protecting the optical path from sunlight when the fixture is off
- Three setup menu presets and preset sync for cross-loading to multiple like fixtures for easy shop setup
- USB slot for software uploads
- Battery backup display with auto-rotate depending on fixture orientation

Product Overview

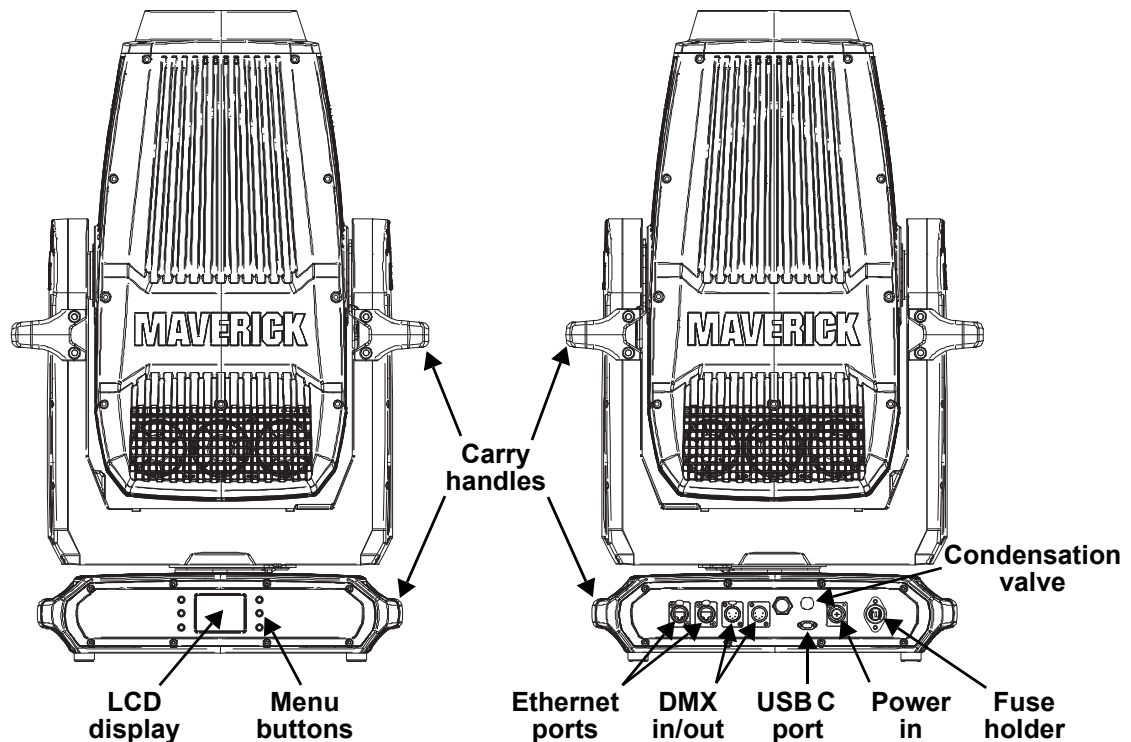

Product Dimensions

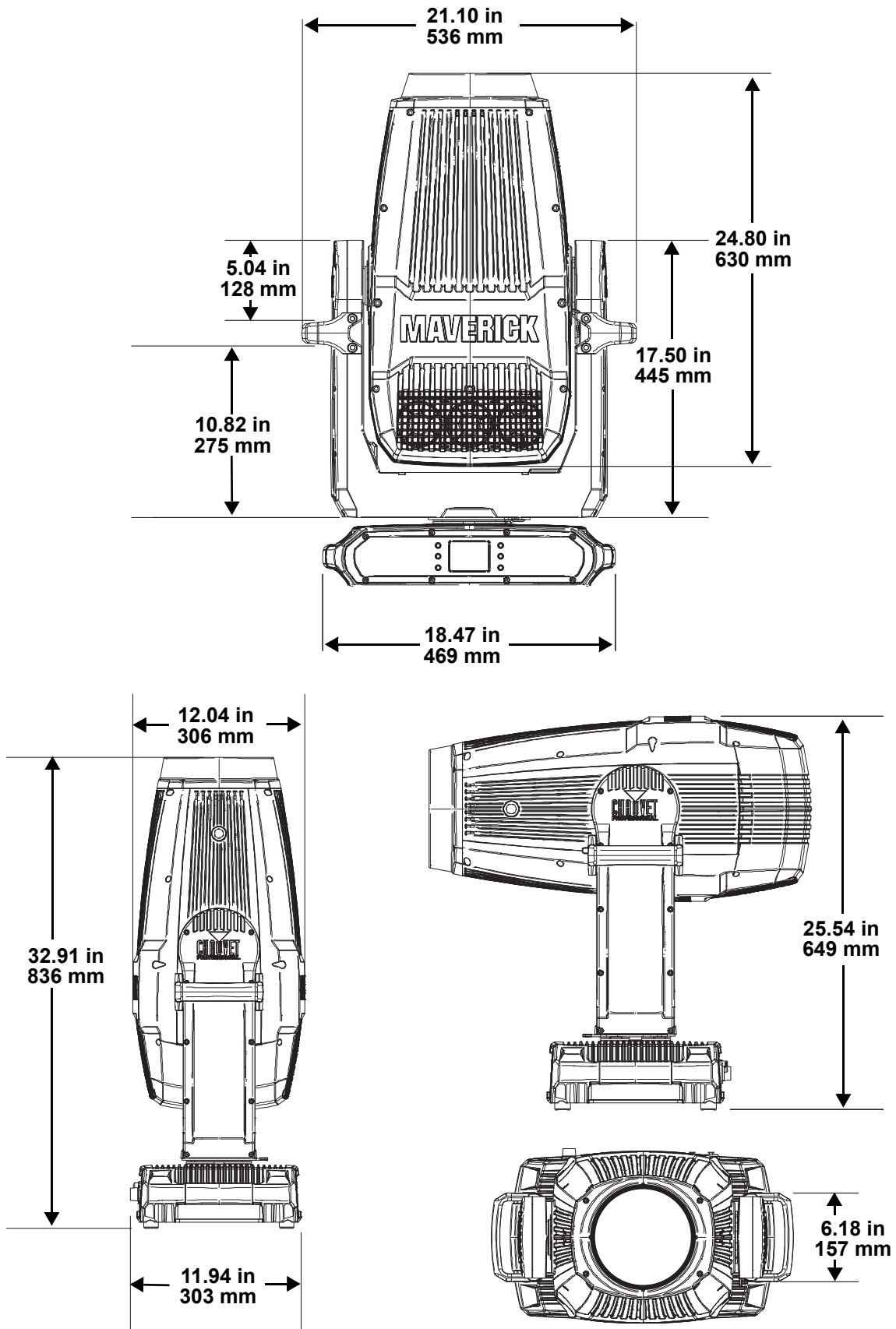

3. Setup

AC Power

The Maverick Storm 4 Profile has an auto-ranging power supply, and it can work with an input voltage range of 100 to 240 VAC, 50/60 Hz.

To determine the product's power requirements (circuit breaker, power outlet, and wiring), use the current value listed on the label affixed to the product's back panel, or refer to the product's specifications chart. The listed current rating indicates the product's average current draw under normal conditions.



- **Always connect the product to a protected circuit (a circuit breaker or fuse). Make sure the product has an appropriate electrical ground to avoid the risk of electrocution or fire.**
- **To eliminate unnecessary wear and improve its lifespan, during periods of non-use completely disconnect the product from power via breaker or by unplugging it.**



Never connect the product to a rheostat (variable resistor) or dimmer circuit, even if the rheostat or dimmer channel serves only as a 0 to 100% switch.

AC Plug

The Maverick Storm 4 Profile comes with a power input cable terminated with a Seetronic Powerkon A connector on one end and bare wire on the other end (U.S. market). Use the table below to wire a plug.

Connection	Wire (U.S.)	Wire (Europe)	Screw Color
AC Live	Black	Brown	Yellow or Brass
AC Neutral	White	Blue	Silver
AC Ground	Green/Yellow	Green/Yellow	Green

Fuse Replacement

1. Disconnect this product from the power outlet.
2. Using a flat-head screwdriver, unscrew the fuse holder cap from the housing.
3. Remove the blown fuse and replace with another fuse of the same type and rating (25 A, 500 V).
4. Screw the fuse holder cap back in place and reconnect power.

USB Software Update

The Maverick Storm 4 Profile allows for software updates with a USB device using the built-in USB port. To update the software using a USB flash drive, do the following:

1. Power on the product, and plug the flash drive into the USB port.
2. Once the flash drive has been detected, the message **"USB UPDATE"** will be displayed. Select **YES**.
3. The next screen will show the software versions available for this fixture on the USB drive. For multiple versions of the software for the same fixture, use **<UP>** or **<DOWN>** to select the desired version. Press **<ENTER>**.
4. The **"USB UPDATE"** screen will re-appear. Select **YES**.



It is possible to update multiple units with the USB if they are daisy chained via DMX.

5. The upgrade will start. **DO NOT** turn off the power or disconnect the USB while the USB LED is still blinking during the process. The screen display will read: **"USB Update Wait"**. The update can take several minutes to complete.
 - When the USB firmware is done uploading, in some fixtures, the display will change to: **"DO NOT UNPLUG, UPDATING"**.
6. When the update is completed, the fixture will automatically reboot.
7. Go to Fixture Information on the product's menu map and confirm the firmware revision.
8. When the boot-up process is finished, restart the product.



- **Place the .chl file in the root directory of the USB drive.**
- **The product's USB port supports up to 32GB capacity and only works with FAT32 file format.**



Turning off the power or removing the USB while the USB LED is still blinking during the update will cause partial or total firmware failure in the targeted fixture(s). If this occurs, the user will need the UPLOAD 08 device to fix this. Please contact Chauvet regarding this device.

Signal Connections

The Maverick Storm 4 Profile can receive a DMX, Art-Net™, or sACN signal. The product has two Amphenol XLRnet through ports, and 5-pin DMX in and out ports. It is possible to control compatible products individually with a single controller.

Control Personalities

The Maverick Storm 4 Profile uses a 5-pin DMX data connection, WDMX, Art-Net™, or sACN for its two control personalities: **Dmx Mode 38 CH** and **Dmx Mode 55 CH**.

- Refer to the [Operation](#) chapter to learn how to configure the Maverick Storm 4 Profile to work in these personalities.
- The [Control Channel Assignments and Values](#) section provides detailed information regarding the control personalities.



For more information about DMX standards or the DMX cables needed to link this product to a DMX controller, download the DMX primer from the Chauvet website: www.chauvetprofessional.com.

DMX Linking

Use a 5-pin DMX connection or a WMDX connection to link a DMX controller to the Maverick Storm 4 Profile. For more information about DMX, read the DMX primer at:

https://www.chauvetprofessional.com/wp-content/uploads/2016/06/DMX_Primer.pdf.

Remote Device Management

Remote Device Management (RDM) is a standard for allowing DMX-enabled devices to communicate bi-directionally along existing DMX cabling. Check the DMX controller's User Manual or with the manufacturer, as not all DMX controllers have this capability. The Maverick Storm 4 Profile supports RDM protocol that allows feedback to make changes to menu map options.

Art-Net™ Connection

Art-Net™ is an Ethernet protocol that uses TCP/IP that transfers a large amount of DMX512 data using an Amphenol XLRnet RJ45 connection over a large network. An Art-Net™ protocol document is available from www.chauvetprofessional.com.

Art-Net™ designed by and copyright Artistic Licence Holdings Ltd.

sACN Connection

Streaming ACN (Architecture for Control Networks), also known as ANSI E1.31, is an Ethernet protocol that uses the layering and formatting of ACN to transport DMX512 data over IP or any other ACN-compatible network.

Connection Diagram

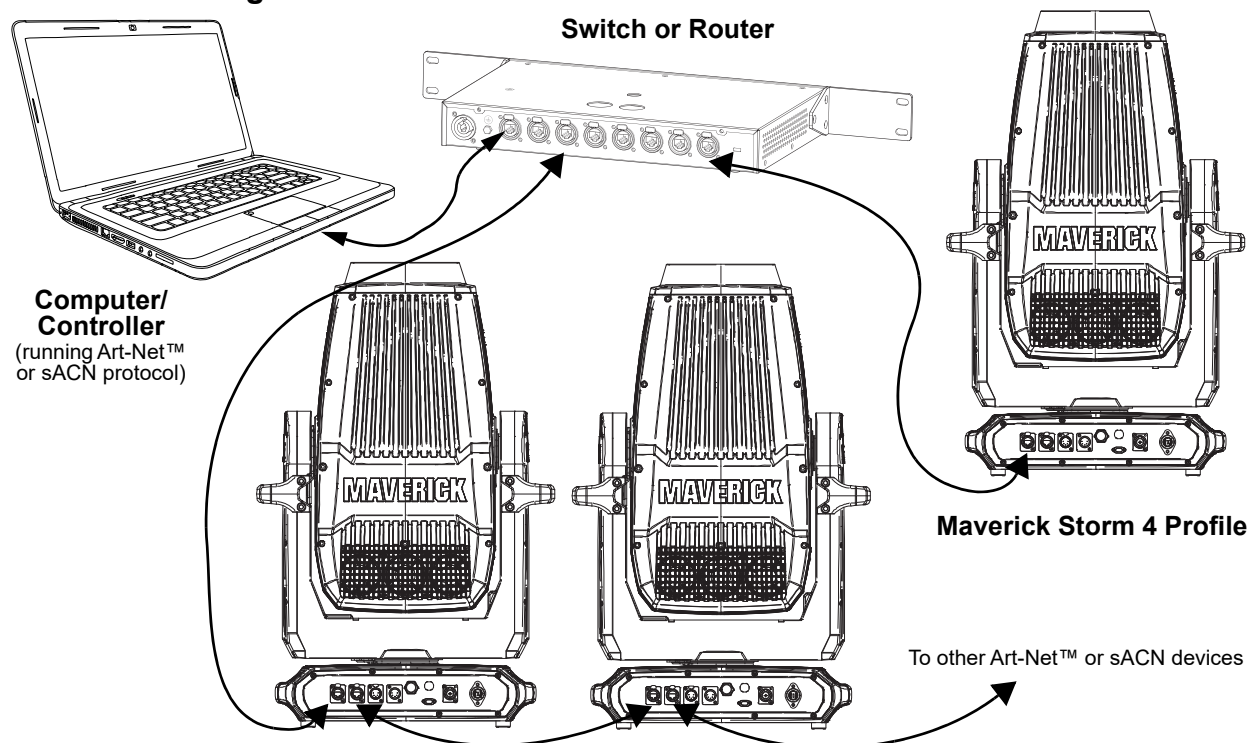

Mounting

Before mounting the product, read and follow the safety recommendations indicated in the [Safety Notes](#). For the Chauvet Professional line of mounting clamps, go to <http://trusst.com/products/>.

Orientation

Always mount this product in a safe position, making sure there is adequate room for ventilation, configuration, and maintenance.

Rigging

Chauvet recommends using the following general guidelines when mounting this product:

- Before deciding on a location for the product, always make sure there is easy access to the product for maintenance and programming.
- Make sure that the structure and attachment points can support the weight before hanging the product (see the [Technical Specifications](#)).
- When mounting the product overhead, always use a safety cable. Mount the product securely to a rigging point, whether an elevated platform or a truss.
- When rigging the product onto a truss, use a mounting clamp of appropriate weight capacity.
- When power linking multiple products, mount the products close enough for power-linking cables to reach.

Procedure

The Maverick Storm 4 Profile comes with 2 Omega brackets. The user can directly attach mounting clamps (sold separately) to these omega brackets. Use at least two mounting points per product. Make sure the clamps are capable of supporting the weight of this product. For the Chauvet Professional line of mounting clamps, go to <http://www.trusst.com/products>.



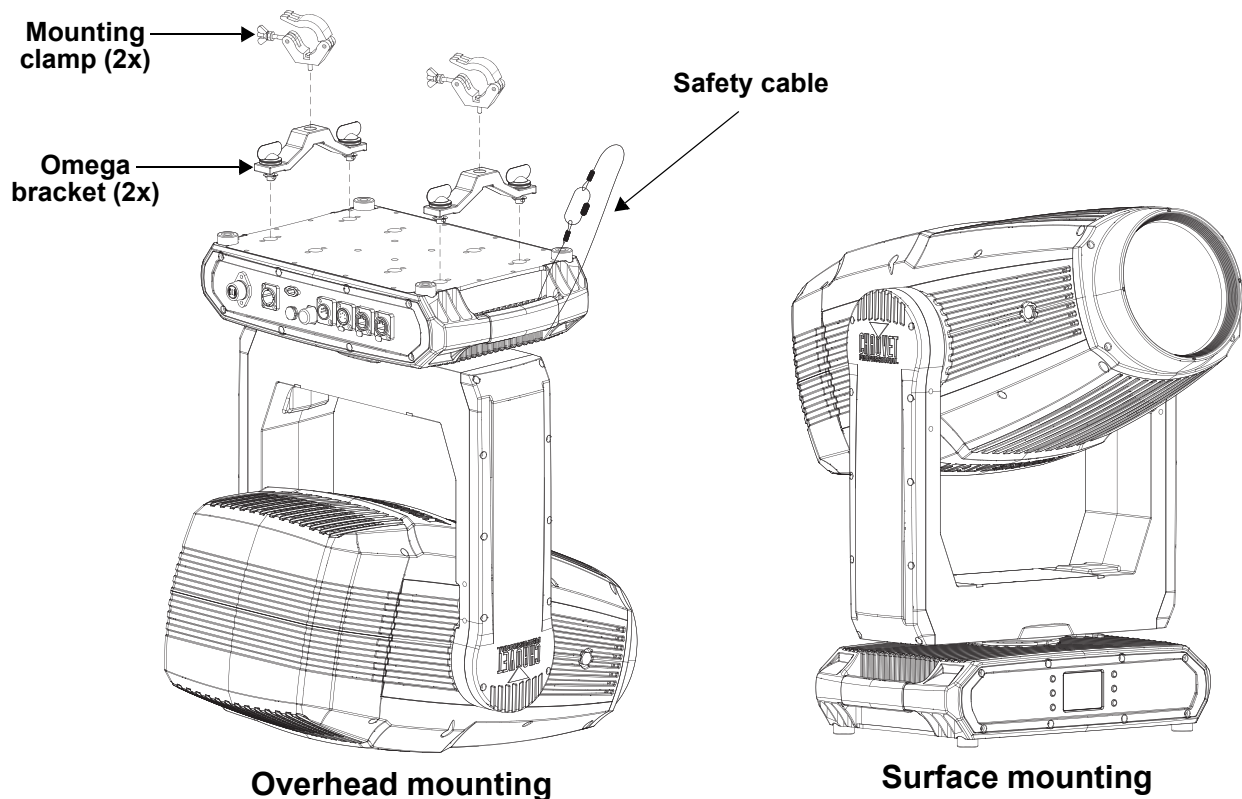



Mounting Diagram



Use the 140-D Omega brackets that is supplied with the fixture when doing an overhead mount.

4. Operation

Control Panel Description

Button	Name	Function
	<UP>	Navigates upwards through the menu list or increases the value when in a function
	<MENU>	Exits from the current menu or function
	<DOWN>	Navigates downwards through the menu list or decreases the value when in a function
	<LEFT>	Navigates leftwards through the menu list
	<ENTER>	Enables the currently displayed menu or sets the selected value into the function
	<RIGHT>	Navigates rightwards through the menu list

Battery-Powered Display

The Maverick Storm 4 Profile has a battery-powered display that enables access to the menu when the product is powered off. Press and hold <MENU> until the display activates (approximately 15 seconds).

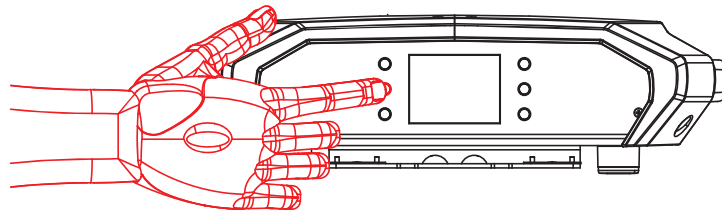

Home Screen

The Maverick Storm 4 Profile has a home screen that shows the current control protocols, personalities, starting addresses, IP addresses, and universes. To see the home screen, press <MENU> repeatedly until it shows on the display. From the home screen, touch any of the displayed control settings to immediately jump to that part of the menu, such as the personality, starting address, or universe, or press <ENTER> to reach the main menu.

Control Panel Lock

The setting locks or unlocks the control panel.

1. Go to the **Settings** main level.
2. Select the **Lock Screen** option.
3. Select **NO** (control panel stays unlocked) or **YES** (locks control panel).



When the control panel lock is activated, the product will prompt for the passcode in order to access the menu. Enter the passcode as described below.

Passcode

After being prompted to enter the passcode, enter the numbers **0920**.

Technician Mode

The technician mode disables the pan and tilt motors, allowing the output of the product to be aimed by hand. To enable the technician mode of the Maverick Storm 4 Profile, hold <UP> and <LEFT> while the product is powering on. When the product is turned off and back on, the pan and tilt will return to normal function.

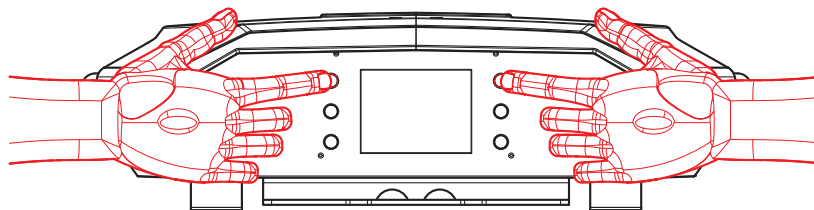

Menu Map

Refer to the Maverick Storm 4 Profile product page on www.chauvetprofessional.com for the latest menu map.

Main Level	Programming Levels		Description
Address	001–512		Sets the starting address
Network Setup	IP Mode	Manual	Manually set IP address
		DHCP	Network sets IP address
		Static	Product sets IP address
	Universe	000–255 (Art-Net™) 001–256 (sACN)	Sets the universe
	Ip	____.____.____.____ (000–255)	Sets the IP address in Manual mode
SubMask	____.____.____.____ (000–255)	Sets the Subnet Mask in Manual mode	
Personality	Dmx Mode 38 CH	NO	Selects the 38-channel mode
	Dmx Mode 55 CH	YES	Selects the 55-channel mode
Settings	Control Mode	DMX	Sets the control protocol
		ArtNet	
		sACN	
		WDMX	
	Pan Reverse	NO	Normal pan
		YES	Reversed pan
	Tilt Reverse	NO	Normal tilt
		YES	Reversed tilt
	Screen Reverse	NO	Normal display orientation
		YES	Inverted display orientation
		AUTO	Automatic display orientation
	Pan Angle	540	540° pan range
		360	360° pan range
		180	180° pan range
	Tilt Angle	270	270° tilt range
		180	180° tilt range
		090	90° tilt range
	BL. O. P/T Move	NO	Enable/disable blackout while panning/tilting
		YES	
	BL. O. ColorMove	NO	Enable/disable blackout while color wheel is moving
		YES	
	BL. O. GoboMove	NO	Enable/disable blackout while gobo wheels are moving
		YES	
	Lock Screen	NO	Lock the buttons
		YES	Passcode: 0920
	Swap XY	NO	Do not swap pan and tilt
		YES	Pan controls tilt, tilt controls pan
	WDMX Reset	NO	Do not reset WDMX
		YES	Reset WDMX
	Backlight Timer	30S	Display turns off after 30 seconds
1M		Display turns off after 1 minute	
5M		Display turns off after 5 minutes	
ON		Display stays on	
Loss of Data	Hold	Holds last signal received	
	Close	Blacks out fixture	

Main Level	Programming Levels		Description
Settings (cont.)	Fans	Auto	Fan speed according to product temperature
		Full	Fan speed set on high
		ECO	Quiet mode
		TV25	Maintains LED output up to an ambient temperature of 77 °F (25 °C) (TV25) or 95 °F (35 °C) (TV35).
		TV35	When using these fan modes, please set the PWM Options to 6000Hz or 15000Hz to prevent any harmonization noise.
	Dimmer Curve	Linear	Set the dimmer curve
		Square	
		I Squa	
		SCurve	
		Linear2	
	PWM Option	600 Hz	Sets the Pulse Width Modulation frequency
		1200 Hz	
		2000 Hz	
		4000 Hz	
		6000 Hz	
	LED POWER	64–255	Sets LED power
	Min Zoom Focus	NO	Enables/disables Min Zoom Focus
		YES	
	Preset Select	PRESET A	Recorded preset menu options
		PRESET B	
		PRESET C	
	Preset Sync	NO	Transfers recorded preset menu options to other Maverick Storm 4 Profile fixtures in the DMX daisy chain
		YES	
USB Update	NO	Update firmware via USB C	
	YES		
Reset Function	Pan/Tilt	NO YES	Reset individual functions or all functions from start-up
	Iris/Prism		
	Color/CMY/ Blade		
	Gobo/Gobo Rotate		
	Frost/ Animation		
	All		
Factory Settings	NO	Reset to factory default settings	
	YES		

Main Level	Programming Levels		Description	
	Auto Test		Auto test all functions	
Test	Manual Test	Pan	Manually control and test all settings through the control panel	
		Pan Fine		
		Tilt		
		Tilt Fine		
		P/T Speed		
		Dimmer		
		Dimmer Fine		
		Shutter		
		Virtual Shaking		
		Cyan		
		Magenta		
		Yellow		
		CTO		
		Color		
		Gobo		
		Gobo Rotate		
		Gobo Index		
		Gobo2		
		Gobo2 Rotate		
		Gobo2 Index		
		Animation		
		Animation Rotate		
		Blade1-1		0-255
		Blade1-1 Fine		
		Blade1-2		
		Blade1-2 Fine		
		Blade2-1		
		Blade2-1 Fine		
		Blade2-2		
		Blade2-2 Fine		
		Blade3-1		
		Blade3-1 Fine		
		Blade3-2		
		Blade3-2 Fine		
Blade4-1				
Blade4-1 Fine				
Blade4-2				
Blade4-2 Fine				
Blade Rotate				
Blade. Rota Fine				
Focus				
Focus Fine				
Focus Auto				
Zoom				
Zoom Fine				

Main Level	Programming Levels		Description		
Test (cont.)	Manual Test (cont.)	Prism	0-255	Manually control and test all settings through the control panel	
		Prism Rotate			
		Prism2			
		Prism2 Rotate			
		Iris			
		Frost			
		Frost2			
		CMY Macro			
		CMY Macro Speed			
		Special Function			
Information	Fixture Information	Ver	V_	Shows firmware version	
		Running Mode	---	Shows current running mode	
		DMX Address	---	Shows current starting address	
		Temperature	---	Shows current product temperature in °C	
		Fixture Hours	-----	Shows hours product has been on	
		LED Hours	-----	Shows hours LED has been on	
		Ip	-----	Shows current IP address	
		SubMask	-----	Shows current Subnet Mask	
	Fan Information	Base Fan1-4	Speed	-----	Shows speed of each fan in rpm
		-FAN_-- (x17)	Speed	-----	
	Error Information		-----		Shows any errors, or No Error!
	Channel Information	Frequency	000-255		Shows all current values from input signals
		Pan			
		Pan Fine			
		Tilt			
		Tilt Fine			
		P/T Speed			
		Dimmer			
		Dimmer Fine			
		Shutter			
		Virtual Shaking			
		Cyan			
		Magenta			
		Yellow			
		CTO			
Color					
Gobo					
Gobo Rotate					
Gobo Index					
Gobo2					
Gobo2 Rotate					
Gobo2 Index					
Animation					
Animation Rotate					

Main Level	Programming Levels		Description
Information (cont.)	Channel Information (cont.)	Blade1- 1	000–255 Shows all current values from input signals
		Blade1- 1 Fine	
		Blade1- 2	
		Blade1- 2 Fine	
		Blade2- 1	
		Blade2- 1 Fine	
		Blade2- 2	
		Blade2- 2 Fine	
		Blade3- 1	
		Blade3- 1 Fine	
		Blade3- 2	
		Blade3- 2 Fine	
		Blade4- 1	
		Blade4- 1 Fine	
		Blade4- 2	
		Blade4- 2 Fine	
		Blade Rotate	
		Blade. Rota Fine	
		Focus	
		Focus Fine	
		Focus Auto	
		Zoom	
		Zoom Fine	
		Prism	
		Prism Rotate	
		Prism2	
		Prism2 Rotate	
		Iris	
		Frost	
		Frost2	
CMY Macro			
CMY Macro Speed			
Special Function			

Operation

Control Configuration

Use control configurations to operate the product with a DMX, Art-Net™, or sACN controller.

Control Mode

The Maverick Storm 4 Profile works with wired DMX, WDMX, Art-Net™, and sACN control signals. To select which protocol to use:

1. Go to the **Settings** main level.
2. Select the **Control Mode** option.
3. Select the desired protocol, from **DMX**, **ArtNet**, **sACN**, or **WDMX**.

Control Personalities

To set the control personality:

1. Go to the **Personality** main level.
2. Select the desired personality, from **Dmx Mode 38 CH** or **Dmx Mode 55 CH**.



- See the [Starting Address](#) section for the highest selectable starting address for each personality.
- Make sure that the starting addresses on the various products do not overlap due to the new personality setting.

Starting Address

Each product will respond to a unique starting address from the controller. All products with the same starting address will respond in unison. To set the starting address:

1. Go to the **Address** main level.
2. Select the starting address (**001–512**).
 - The highest recommended starting address for **Dmx Mode 38 CH** is **475**.
 - The highest recommended starting address for **Dmx Mode 55 CH** is **458**.

Network Setup

The Network Setup settings control the IP address, subnet mask, and universe of the product.

IP Mode

To choose how the IP address is set:

1. Go to the **Network Setup** main level.
2. Select the **IP Mode** option.
3. Select the desired IP mode, from **Manual** (to set a custom IP address), **DHCP** (the IP address is assigned by the connected network), or **Static** (the product uses a default, preset IP address).

Universe

To assign an Art-Net™ or sACN universe to the Maverick Storm 4 Profile:

1. Go to the **Network Setup** main level.
2. Select the **Universe** option.
3. Set the universe, from **000–255** (for Art-Net™) or from **001–256** (for sACN).

Manual IP Address

To set the IP address when the **IP Mode** is set to **Manual**:

1. Go to the **Network Setup** main level.
2. Select the **Ip** option.
3. Set the 4 values of the IP address from **000–255**.

Subnet Mask

To set the subnet mask:

1. Go to the **Network Setup** main level.
2. Select the **SubMask** option.
3. Set the 4 values of the subnet mask from **000–255**.

Control Channel Assignments and Values

38CH	55CH	Function	Value	Percent/Setting
1	1	Pan	000 ⇔ 255	0–100%
2	2	Fine pan	000 ⇔ 255	Fine control (16-bit)
3	3	Tilt	000 ⇔ 255	0–100%
4	4	Fine tilt	000 ⇔ 255	Fine control (16-bit)
5	5	Pan/tilt speed	000 ⇔ 255	Fast to slow
6	6	Dimmer	000 ⇔ 255	0–100%
–	7	Fine dimmer	000 ⇔ 255	Fine control (16-bit)
7	8	Strobe	000 ⇔ 003	Off
			004 ⇔ 007	On
			008 ⇔ 076	Synchronized strobe, slow to fast
			077 ⇔ 145	Pulse strobe, slow to fast
			146 ⇔ 215	Random strobe, slow to fast
8	9	Virtual shaking	000 ⇔ 001	No function
			002 ⇔ 128	Shaking effect, slow to fast
			129 ⇔ 255	Fade effect, slow to fast
9	10	Cyan	000 ⇔ 255	0–100%
10	11	Magenta	000 ⇔ 255	0–100%
11	12	Yellow	000 ⇔ 255	0–100%
12	13	CTO	000 ⇔ 255	0–100%
13	14	Color wheel	000 ⇔ 007	Open
			008 ⇔ 015	Color 1
			016 ⇔ 023	Color 2
			024 ⇔ 031	Color 3
			032 ⇔ 039	Color 4
			040 ⇔ 047	Color 5
			048 ⇔ 059	Color 6
			060 ⇔ 187	Color wheel indexing
			188 ⇔ 219	Color scroll, fast to slow
14	15	Gobo wheel 1 (see Gobo Wheels)	220 ⇔ 223	Stop
			224 ⇔ 255	Reverse color scroll, slow to fast
			001 ⇔ 007	Open
			008 ⇔ 015	Gobo 1 (Dots)
			016 ⇔ 023	Gobo 2 (Paperclip Party)
			024 ⇔ 031	Gobo 3 (Orbital)
			032 ⇔ 039	Gobo 4 (Dirty Dirt)
			040 ⇔ 047	Gobo 5 (Box Cutter)
			048 ⇔ 063	Gobo 6 (Crazy Turns)
			064 ⇔ 071	Gobo 6 shaking, slow to fast
			072 ⇔ 079	Gobo 5 shaking, slow to fast
			080 ⇔ 087	Gobo 4 shaking, slow to fast
			088 ⇔ 095	Gobo 3 shaking, slow to fast
096 ⇔ 103	Gobo 2 shaking, slow to fast			
104 ⇔ 111	Gobo 1 shaking, slow to fast			
112 ⇔ 127	Open			
128 ⇔ 191	Gobo scroll, slow to fast			
192 ⇔ 255	Reverse gobo scroll, slow to fast			

Operation

38CH	55CH	Function	Value	Percent/Setting
15	16	Gobo wheel 1 rotate	000 ⇔ 063	Gobo index
			064 ⇔ 145	Rotation, fast to slow
			146 ⇔ 149	Stop
			150 ⇔ 231	Reverse rotation, slow to fast
			232 ⇔ 255	Alternating clockwise/counterclockwise rotation, short to long
-	17	Gobo 1 fine rotate	000 ⇔ 255	Fine control (16-bit)
16	18	Gobo wheel 2 (see Gobo Wheels)	001 ⇔ 007	Open
			008 ⇔ 015	Gobo 1 (Pipes & Poles)
			016 ⇔ 023	Gobo 2 (Cookie Cutter)
			024 ⇔ 031	Gobo 3 (This Way)
			032 ⇔ 039	Gobo 4 (Fast Moves)
			040 ⇔ 047	Gobo 5 (Laser Rays)
			048 ⇔ 063	Gobo 6 (Limbo)
			064 ⇔ 071	Gobo 6 shaking, slow to fast
			072 ⇔ 079	Gobo 5 shaking, slow to fast
			080 ⇔ 087	Gobo 4 shaking, slow to fast
			088 ⇔ 095	Gobo 3 shaking, slow to fast
			096 ⇔ 103	Gobo 2 shaking, slow to fast
			104 ⇔ 111	Gobo 1 shaking, slow to fast
			112 ⇔ 127	Open
			128 ⇔ 191	Gobo scroll, slow to fast
192 ⇔ 255	Reverse gobo scroll, slow to fast			
17	19	Gobo wheel 2 rotate	000 ⇔ 063	Gobo index
			064 ⇔ 145	Rotation, fast to slow
			146 ⇔ 149	Stop
			150 ⇔ 231	Reverse rotation, slow to fast
			232 ⇔ 255	Alternating clockwise/counterclockwise rotation, short to long
-	20	Gobo 2 fine rotate	000 ⇔ 255	Fine control (16-bit)
18	21	Animation wheel	000 ⇔ 255	0-100%
19	22	Animation wheel rotate	000 ⇔ 124	Rotation, fast to slow
			125 ⇔ 130	Stop
			131 ⇔ 255	Reverse rotation, slow to fast
20	23	Blade 1-1	000 ⇔ 255	0-100%
-	24	Fine blade 1-1	000 ⇔ 255	Fine control (16-bit)
21	25	Blade 1-2	000 ⇔ 255	0-100%
-	26	Fine blade 1-2	000 ⇔ 255	Fine control (16-bit)
22	27	Blade 2-1	000 ⇔ 255	0-100%
-	28	Fine blade 2-1	000 ⇔ 255	Fine control (16-bit)
23	29	Blade 2-2	000 ⇔ 255	0-100%
-	30	Fine blade 2-2	000 ⇔ 255	Fine control (16-bit)
24	31	Blade 3-1	000 ⇔ 255	0-100%
-	32	Fine blade 3-1	000 ⇔ 255	Fine control (16-bit)
25	33	Blade 3-2	000 ⇔ 255	0-100%
-	34	Fine blade 3-2	000 ⇔ 255	Fine control (16-bit)
26	35	Blade 4-1	000 ⇔ 255	0-100%
-	36	Fine blade 4-1	000 ⇔ 255	Fine control (16-bit)
27	37	Blade 4-2	000 ⇔ 255	0-100%

38CH	55CH	Function	Value	Percent/Setting
-	38	Fine blade 4-2	000 ⇔ 255	Fine control (16-bit)
28	39	Blade rotation	000 ⇔ 255	0–100%
-	40	Fine blade rotation	000 ⇔ 255	Fine control (16-bit)
29	41	Focus	000 ⇔ 255	0–100%
-	42	Fine focus	000 ⇔ 255	Fine control (16-bit)
-	43	Auto focus	000 ⇔ 010 011 ⇔ 030 031 ⇔ 050 051 ⇔ 070 071 ⇔ 090 091 ⇔ 110 111 ⇔ 130 131 ⇔ 150 151 ⇔ 170 171 ⇔ 190 191 ⇔ 210 211 ⇔ 255	No function 0-5 meters 6 meters 7 meters 8 meters 9 meters 10 meters 12.5 meters 15 meters 17.5 meters 20-60 meters Auto detect distance
30	44	Zoom	000 ⇔ 255	0–100%
-	45	Fine zoom	000 ⇔ 255	Fine control (16-bit)
31	46	Prism 1	000 ⇔ 004 005 ⇔ 255	No function Prism insert
32	47	Prism 1 rotate	000 ⇔ 127 128 ⇔ 189 190 ⇔ 193 194 ⇔ 255	Prism index Clockwise rotation, fast to slow Stop Counterclockwise rotation, slow to fast
33	48	Prism 2	000 ⇔ 004 005 ⇔ 255	No function Prism insert
34	49	Prism 2 rotate	000 ⇔ 127 128 ⇔ 189 190 ⇔ 193 194 ⇔ 255	Prism index Clockwise rotation, fast to slow Stop Counterclockwise rotation, slow to fast
35	50	Iris	000 ⇔ 063 064 ⇔ 127 128 ⇔ 191 192 ⇔ 255	Big to small Auto change, slow to fast Slow open, fast close, slow to fast Fast open, slow close, slow to fast
36	51	Frost 1	000 ⇔ 255	0–100%
37	52	Frost 2	000 ⇔ 255	0–100%
-	53	CMY macro	000 ⇔ 009 010 ⇔ 255	No function CMY macro
-	54	CMY macro speed	000 ⇔ 255	Fast to slow

38CH	55CH	Function	Value	Percent/Setting
38	55	Control (3 second hold)	000 ⇔ 007	No function
			008 ⇔ 015	Blackout during pan/tilt
			016 ⇔ 023	Blackout while color wheel is moving
			024 ⇔ 031	Blackout while gobo wheels are moving
			032 ⇔ 039	Blackout during pan/tilt/color wheel
			040 ⇔ 047	Blackout during pan/tilt/gobo wheels
			048 ⇔ 055	Blackout during pan/tilt/color wheel/gobo wheels
			056	No function
			057	600 Hz PWM
			058	1200 Hz PWM
			059	2000 Hz PWM
			060	4000 Hz PWM
			061	6000 Hz PWM
			062	15000 Hz PWM
			063	No function
			064	Linear dimmer curve
			065	Square dimmer curve
			066	Inverse square dimmer curve
			067	S-curve dimmer curve
			068	Linear 2 dimmer curve
			069 ⇔ 095	No function
			096 ⇔ 103	Pan reset
			104 ⇔ 111	Tilt reset
			112 ⇔ 119	Color wheel reset
			120 ⇔ 127	Gobo wheels reset
			128 ⇔ 135	No function
			136 ⇔ 143	Prism reset
			144 ⇔ 151	Blades reset
			152 ⇔ 159	All reset
			160 ⇔ 167	Iris reset
			168 ⇔ 175	Frost/animation wheel reset
			176 ⇔ 183	Zoom reset
			184 ⇔ 191	CMY/CTO reset
			192 ⇔ 199	Fan mode ECO
			200 ⇔ 207	Fan mode Full
			208 ⇔ 215	Fan mode Auto
			216 ⇔ 220	Fan mode TV25
			221 ⇔ 225	Fan mode TV35
			226 ⇔ 230	No function
			231 ⇔ 235	Pan/tilt swap on
			236 ⇔ 240	Pan/tilt swap off
			241 ⇔ 245	Min Zoom Focus off
246 ⇔ 250	Min Zoom Focus on			
251 ⇔ 255	No function			

Configuration Settings

Pan Reverse

To set the orientation of the pan:

1. Go to the **Settings** main level.
2. Select the **Pan Reverse** option.
3. Select from **NO** (normal pan motion), or **YES** (reversed pan motion).

Tilt Reverse

To set the orientation of the tilt:

1. Go to the **Settings** main level.
2. Select the **Tilt Reverse** option.
3. Select from **NO** (normal tilt motion), or **YES** (reversed tilt motion).

Screen Reverse

To set the orientation of the display:

1. Go to the **Settings** main level.
2. Select the **Screen Reverse** option.
3. Select from **NO** (right-side up), **YES** (upside-down), or **AUTO** (automatic orientation).

Pan Angle

To set the maximum angle of the pan:

1. Go to the **Settings** main level.
2. Select the **Pan Angle** option.
3. Select from **540** (540°), **360** (360°), or **180** (180°).

Tilt Angle

To set the maximum angle of the tilt:

1. Go to the **Settings** main level.
2. Select the **Tilt Angle** option.
3. Select from **270** (260°), **180** (180°), or **090** (90°).

Black out on Movement

To set the product to black out while the pan/tilt, color wheel, or gobo wheels are moving:

1. Go to the **Settings** main level.
2. Select from the **BL. O. P/T Move** (black out on pan/tilt movement), **BL. O. ColorMove** (black out on color wheel movement), or **BL. O. GoboMove** (black out on gobo wheel movement) options.
3. Select from **NO** or **YES**.

Swap Pan and Tilt

To swap the controls for the pan and tilt:

1. Go to the **Settings** main level.
2. Select the **Swap XY** option.
3. Select from **NO** (pan controls pan, tilt controls tilt) or **YES** (pan controls tilt, tilt controls pan).

WDMX Reset

To reset the WDMX connection:

1. Go to the **Settings** main level.
2. Select the **WDMX Reset** option.
3. Select from **NO** or **YES**.

Display Backlight Timer

To set how long before an inactive display will turn off:

1. Go to the **Settings** main level.
2. Select the **Backlight Timer** option.
3. Select the length of the backlight timer, from **30S** (30 seconds), **1M** (1 minute), **5M** (5 minutes), or **ON** (always on).

Operation

Loss of Data

To set how the product reacts to a loss of in control signal data:

1. Go to the **Settings** main level.
2. Select the **Loss of Data** option.
3. Select **Hold** (holds the last values received before signal loss) or **Close** (blacks out the product).

Fan Mode

To set the fan speed mode:

1. Go to the **Settings** main level.
2. Select the **Fans** option.
3. Select the fan mode, from **Auto** (fan speed adjusts to product temperature), **Full** (fan speed at maximum), **ECO** (quiet mode), **TV25** (maintains LED output up to an ambient temperature of 77 °F [25 °C]), or **TV35** (maintains LED output up to an ambient temperature of 95 °F [35 °C]).



When using the TV25 or TV35 fan mode, please set the PWM Options ([Pulse Width Modulation](#)) to 6000Hz or 15000Hz to prevent any harmonization noise.

Dimmer Curve

To set the dimmer curve:

1. Go to the **Settings** main level.
2. Select the **Dimmer Curve** option.
3. Select the dimmer curve, from **Linear**, **Square**, **I Squa**, **SCurve**, or **Linear2**.

Pulse Width Modulation

To adjust the frequency of the pulse width modulation:

1. Go to the **Settings** main level.
2. Select the **PWM Option** option.
3. Select the frequency, from **600Hz**, **1200Hz**, **2000Hz**, **4000Hz**, **6000Hz**, or **15000Hz**.

LED Power

To set the power of each LED color:

1. Go to the **Settings** main level.
2. Select the **LED POWER** option.
3. Set the LED power from **64–255**.

Minimum Zoom Focus

To enable or disable the Min Zoom Focus function:

1. Go to the **Settings** main level.
2. Select the **Min Zoom Focus** option.
3. Select **NO** (manual independent zoom control) or **YES** (focus adjusts depending on zoom setting).

Preset Selection

To select a preset configuration of menu options:

1. Go to the **Settings** main level.
2. Select the **Preset Select** option.
3. Select from **PRESET A** (default), **PRESET B**, or **PRESET C**.



- **Changes to settings automatically save to the currently selected Preset.**
- **If no Preset has been selected, changes to settings save to PRESET A.**
- **After selecting a Preset, the product will restart.**

Preset Synchronization

To transfer saved Presets from one Maverick Storm 4 Profile to another:

1. Connect the Maverick Storm 4 Profile products to receive the Presets by a DMX daisy chain.
2. Make the Maverick Storm 4 Profile with the Presets to transfer the first in the DMX daisy chain.
3. Power on all of the products.
4. Set all of the products to a [Control Mode](#) other than **WDMX**. (**DMX**, **ArtNet**, or **sACN**)
5. On the Maverick Storm 4 Profile with the Presets, go to the **Settings** main level.
6. Select the **Preset Sync** option.
7. Select **NO** (to cancel) or **YES** (to transfer the Presets to the connected products).



- **All menu configurations are transferred except for the IP address.**
- **ONLY connect Maverick Storm 4 Profile products for this function!**

USB Update

To enable or disable software update using USB:

1. Go to the **Settings** main level.
2. Select the **USB Update** option.
3. Select **NO** (disables software update through USB) or **YES** (enables software update through USB).



See the [USB Software Update](#) section for the detailed instructions on how to update the Maverick Storm 4 Profile software using a USB C connection.

Reset Function

To reset specific functions or the entire product:

1. Go to the **Settings** main level.
2. Select the **Reset Function** option.
3. Select the functions to reset, from **Pan/Tilt**, **Iris/Prism**, **Color/CMY/Blade**, **Gobo/Gobo Rotate**, **Frost/Animation**, or **All**.
4. Select **NO** (to cancel) or **YES** (to reset the selected functions).

Factory Reset

To reset the product to factory settings:

1. Go to the **Settings** main level.
2. Select the **Factory Settings** option.
3. Select **NO** (to cancel) or **YES** (to reset the product configuration).

Test Mode

Auto Test

To have the Maverick Storm 4 Profile automatically test all functions one after the other:

1. Go to the **Test** main level.
2. Select the **Auto Test** option.

Manual Test

To manually test an individual function of the Maverick Storm 4 Profile:

1. Go to the **Test** main level.
2. Select the **Manual Test** option.
3. Select a function to test, from **Pan**, **Pan Fine**, **Tilt**, **Tilt Fine**, **P/T Speed**, **Dimmer**, **Dimmer Fine**, **Shutter**, **Virtual Shaking**, **Cyan**, **Magenta**, **Yellow**, **CTO**, **Color**, **Gobo**, **Gobo Rotate**, **Gobo Index**, **Gobo2**, **Gobo2 Rotate**, **Gobo2 Index**, **Animation**, **Animation Rotate**, **Blade1-1**, **Blade1-1 Fine**, **Blade1-2**, **Blade1-2 Fine**, **Blade2-1**, **Blade2-1 Fine**, **Blade2-2**, **Blade2-2 Fine**, **Blade3-1**, **Blade3-1 Fine**, **Blade3-2**, **Blade3-2 Fine**, **Blade4-1**, **Blade4-1 Fine**, **Blade4-2**, **Blade4-2 Fine**, **Blade Rotate**, **Blade Rota Fine**, **Focus**, **Focus Fine**, **Focus Auto**, **Zoom**, **Zoom Fine**, **Prism**, **Prism Rotate**, **Prism2**, **Prism2 Rotate**, **Iris**, **Frost**, **Frost2**, **CMY Macro**, **CMY Macro Speed**, or **Special Function**.
4. Increase or decrease the value of the selected function from **0–255** to test it.

Operation

System Information

The information section of the menu displays statistics and the current status of the product's various functions. To view this information:

1. Go to the **Information** main level.
2. Select from the **Fixture Information**, **Fan Information**, **Error Information**, or **Channel Information** options.
3. Use **<UP>** and **<DOWN>** to view all information.

Offset Mode

The Offset mode provides fine adjustments for the home position of every moving part in the optical path as well as the pan and tilt movements. To adjust these options and prevent borders showing or reduction of the light output:

1. From the main level screen, press and hold **<MENU>** until the passcode screen appears.
2. Enter the passcode: **0920** and press **<ENTER>**.
3. Select the "zero" position to adjust, from **PAN**, **TILT**, **COLOR**, **GOBO**, **GOBO ROTATE**, **GOBO2**, **FOCUS-GOBO**, **FOCUS-GOBO2**, **ZOOM**, **PRISM**, **PRISM ROT**, **IRIS**, **FROST**, **FROST2**, **CYAN**, **MAGENTA**, **YELLOW**, **CTO**, **DIMMER**, **MAC4**, **MAC5**, or **MAC6**.
4. Adjust the "zero" position for the selected function from **000–255**.

Web Server

The Maverick Storm 4 Profile Web Server can be accessed by any computer on the same network as the product. It allows network access to system information, settings such as control setup, manual testing of all functions, firmware updates, and the ability to change the Web Server password.

1. Connect the product to power, and set the [Control Mode](#) to **ArtNet** and the [IP Mode](#) to **Static**.
2. Connect the product to a Windows computer with a network cable.
3. On the computer, set the first value of the IP address of the new network to match the first value of the IP address of the product. The IP address of the product is displayed on the [Home Screen](#).
4. Enter the IP address of the product into the URL bar of a web browser on the computer.
5. Enter both the User Name and Password as **admin** to log in.

Information

The Information page on the Web Server displays the current settings and the system information of the Maverick Storm 4 Profile.

Setup

The Setup page on the Web Server provides options for control, similar to the **Setup** menu on the product. Click **Save Settings** to send the new configuration to the product.

Manual Test

The Manual Test page on the Web Server allows all output functions of the product to be controlled through the browser. To set all functions back to default, click **Reset**.

Firmware Update

The Upgrade page on the Web Server allows the product to be updated with the latest firmware. Go to <https://www.chauvetprofessional.com> to download firmware updates.

Security

The Security page on the Web Server gives the option to change the password to the connected product's web server. Enter the old password (**admin**, by default) and the new password twice, then click **Save Settings** to change the password.

Gobo Wheels

Gobo Wheel 1

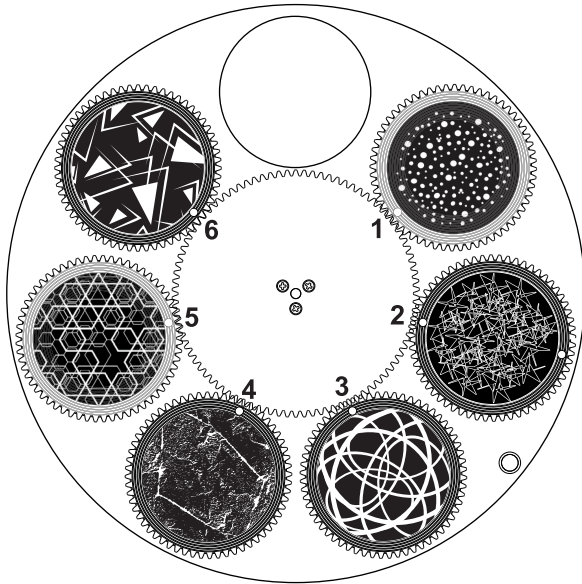

Gobo Wheel 2

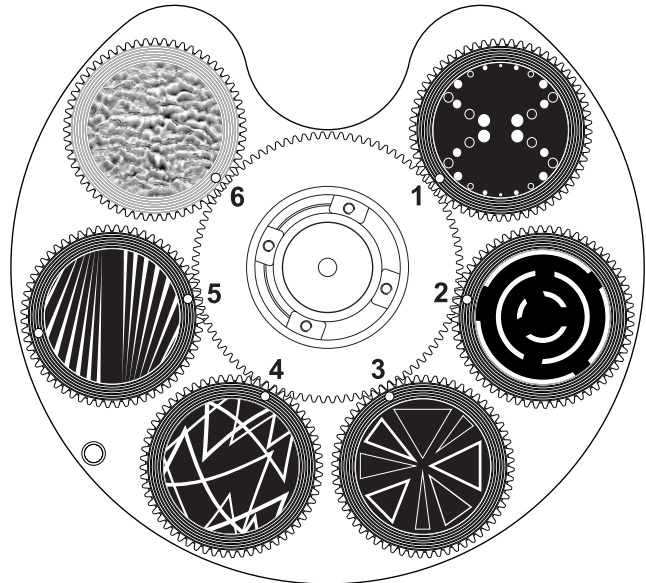

Gobo Wheel	Gobo #	Description	Gobo Wheel	Gobo #	Description
1	1	Dots	2	1	Pipes & Poles
	2	Paperclip Party		2	Cookie Cutter
	3	Orbital		3	This Way
	4	Dirty Dirt		4	Fast Moves
	5	Box Cutter		5	Laser Rays
	6	Crazy Turns		6	Limbo

Gobo Dimensions

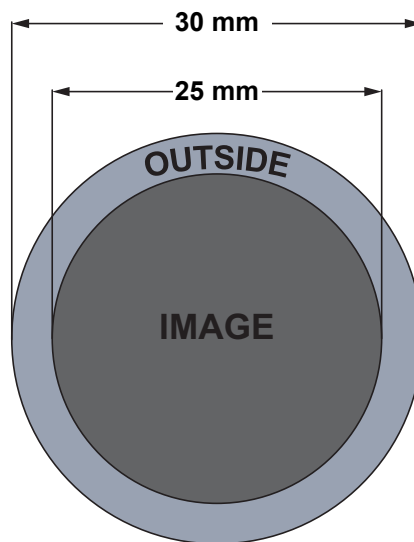

Operation

Gobo Replacement

The gobos in both gobo wheels are removable from their gobo holder. This operation is quite simple, although it requires the technician to carefully follow the recommended procedure.

- **Make sure to disconnect the product's power cord before replacing a gobo.**
- **Always replace a gobo with a gobo of the same dimensions.**
- **When inserting a glass gobo, always make sure that the shiny side of the gobo (glass base) faces the light source. This provides a layer of protection against the high temperature from the LED.**

Procedure

1. Turn the product off and disconnect it from the power outlet.
2. Open the head cover by loosening the screws on the top cover.
3. Separate the gobo holder away from the gobo wheel by pushing it toward the front of the moving head (direction 1 in the diagram). Be careful not to push the gobo out of the gobo holder.
4. Extract the gobo holder by pulling it outward (direction 2 in the diagram).
5. On a flat surface, remove the expansion ring that holds the gobo in place and remove the gobo from the gobo holder.
6. Insert a new gobo and hold it in place with the expansion ring.
7. Slide the tip of the gobo holder under the pressure plate near the center of the gobo wheel.
8. Push the gobo holder inwards. DO NOT force the gobo holder into the gobo wheel slot. If correctly installed, the gobo holder should easily slide into the gobo wheel slot.

Diagram

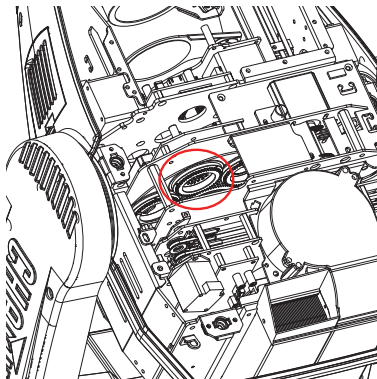

Locate

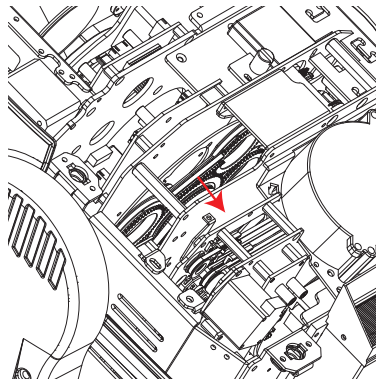

Pull Back

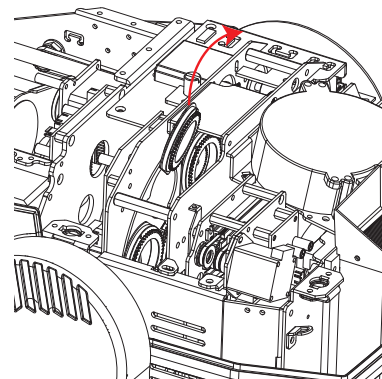

Remove

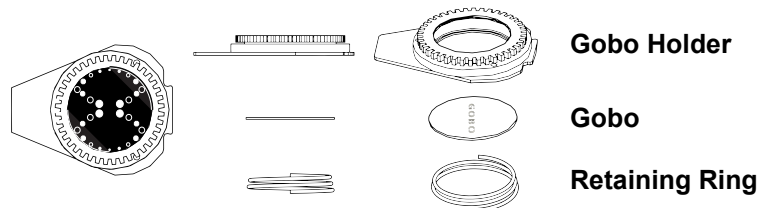
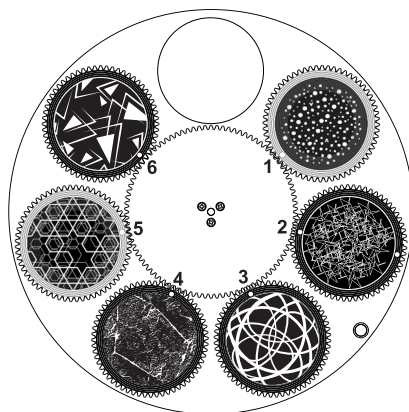

5. Maintenance

Product Maintenance

Dust build-up reduces light output performance and can cause overheating. This can lead to reduction of the light source's life and/or mechanical wear. To maintain optimum performance and minimize wear, clean all lighting products at least twice a month. However, be aware that usage and environmental conditions could be contributing factors to increase the cleaning frequency.

To clean the product, follow the instructions below:

1. Unplug the product from power.
2. Wait until the product is at room temperature.
3. Use a vacuum (or dry compressed air) and a soft brush to remove dust collected on the external surface/vents.
4. Clean all transparent surfaces with a mild soap solution, ammonia-free glass cleaner, or isopropyl alcohol.
5. Apply the solution directly to a soft, lint free cotton cloth or a lens cleaning tissue.
6. Softly drag any dirt or grime to the outside of the transparent surface.
7. Gently polish the transparent surfaces until they are free of haze and lint.



Always dry the transparent surfaces carefully after cleaning them.



Do not spin the cooling fans with compressed air. Damage may result.

Torque Measurements

To maintain the IP rating when reassembling the product, use the given torque measurements for each of the following screws and bolts:

Fixture Parts	Torque Rating (Kgf.cm)	Torque Rating (lgb.in)
Screws inside feet	15.3	13.3
Base screws around outside (not the feet)	53	46
Base screws in middle	89.7	77.8
Omega bracket holder	12.2	10.6
Front and rear base cover	25.5	22.1
Screws around power and data ports	3.5	3
Fuse	10.7	9.2
Center of yoke plate	25.5	22.1
Arm cover screws	25.5	22.1
Allen Key screws holding in front lens cover	12.2	10.6
Allen Key screws next to heat pipes on the back	25.5	22.1
Allen Key screws head covers	25.5	22.1

Vacuum Test Measurements

Use the IP Tester from Chauvet Professional to ensure the product has been reassembled correctly by following the information below:

Parameters	Values
Method	Positive
Test pressure	2.18 kPa
Test duration	60 seconds
PASS state leak pressure	<0.02 kPa

Transporting on Truss or Racks

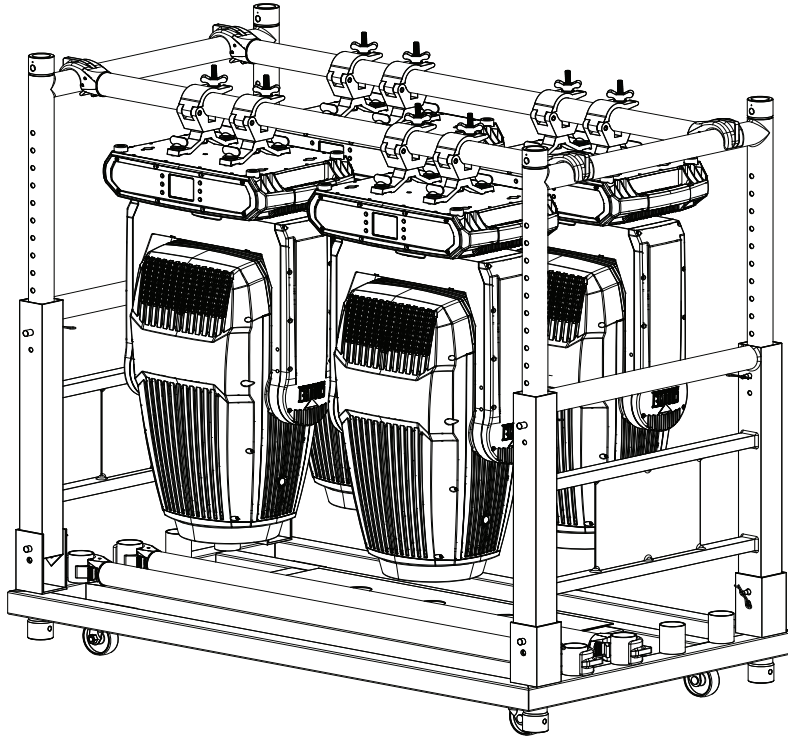

When transporting fixtures in pre-rigged truss and transportation racks, mount fixtures in the vertical position with the lenses facing down and the pan and tilt locks engaged. This is to prevent undue stress on the tilt locks and limit the amount of off-axis bounce on internal components.

6. Technical Specifications

Dimensions and Weight

Length	Width	Height	Weight
18.30 in (465 mm)	11.93 in (303 mm)	32.91 in (836 mm)	110.8 lb (50.3 kg)

Note: Dimensions in inches are rounded.

Power

Power Supply Type	Range	Voltage Selection
Switching (internal)	100 to 240 VAC, 50/60 Hz	Auto-ranging

Parameter	100 V, 60 Hz	120 V, 60 Hz	208 V, 60 Hz	230 V, 50 Hz	240 V, 50 Hz
Consumption	1892 W	1780 W	1740 W	1760 W	1780 W
Operating Current	18.92 A	15.07 A	8.70 A	7.79 A	7.51 A
Fuse/Breaker	25 A, 500 V	25 A, 500 V	25 A, 500 V	25 A, 500 V	25 A, 500 V

Power I/O	U.S./Worldwide	UK/Europe
Power Input Connector	Seetronic Powerkon A	Seetronic Powerkon A
Power Cable Plug	Bare end	Bare end

Light Source

Type	Color	Quantity	Power	Current	Lifespan
LED	Cool White	1	1250 W	4 A	50,000 hours

Photometrics

Beam Angle	Field Angle	Cutoff Angle	Zoom Angle
5.6° to 48°	6.6° to 54.4°	7.1° to 56.8°	5.6° to 56.8°

Illuminance @ 5 m (5.6°)	Illuminance @ 5 m (54.4°)
134,034 lux	4,241 lux

Thermal

Maximum External Temperature	Cooling System
113 °F (45 °C)	Fan-assisted Convection

Control

DMX I/O Connector	Ethernet I/O Connector	Channel Range
5-pin IP-rated XLR	Neutrik IP-rated RJ45	38 or 55

Ordering

Product Name	Item Name	Item Code	UPC Number
Maverick Storm 4 Profile	MAVERICKSTORM4PROFILE	08011958	781462223069



UL 1573
CSA C22.2 No. 166
E113093



Contact Us

General Information	Technical Support
Chauvet World Headquarters	
Address: 3360 Davie Rd., Suite 509 Davie, FL 33314 Voice: (954) 577-4455 Fax: (954) 929-5560 Toll Free: (800) 762-1084	Voice: (844) 393-7575 Fax: (954) 756-8015 Email: chauvetcs@chauvetlighting.com Website: www.chauvetprofessional.com
Chauvet U.K.	
Address: Pod 1 EVO Park Little Oak Drive, Sherwood Park Nottinghamshire, NG15 0EB UK Voice: +44 (0) 1773 511115 Fax: +44 (0) 1773 511110	Email: UKtech@chauvetlighting.eu Website: www.chauvetprofessional.eu
Chauvet Benelux	
Address: Stokstraat 18 9770 Kruishoutem Belgium Voice: +32 9 388 93 97	Email: BNLtech@chauvetlighting.eu Website: www.chauvetprofessional.eu
Chauvet France	
Address: 3, Rue Ampère 91380 Chilly-Mazarin France Voice: +33 1 78 85 33 59	Email: FRtech@chauvetlighting.fr Website: www.chauvetprofessional.eu
Chauvet Germany	
Address: Bruno-Bürgel-Str. 11 28759 Bremen Germany Voice: +49 421 62 60 20	Email: DEtech@chauvetlighting.de Website: www.chauvetprofessional.eu
Chauvet Mexico	
Address: Av. de las Partidas 34 - 3B (Entrance by Calle 2) Zona Industrial Lerma Lerma, Edo. de México, CP 52000 Voice: +52 (728) 690-2010	Email: servicio@chauvet.com.mx Website: www.chauvetprofessional.mx

Warranty & Returns

For warranty terms and conditions and return information, please visit our website.

For customers in the United States and Mexico: www.chauvetlighting.com/warranty-registration.

For customers in the United Kingdom, Republic of Ireland, Belgium, the Netherlands, Luxembourg, France, and Germany: www.chauvetlighting.eu/warranty-registration.